



ME400W WATER COOLED WELDING TORCHES MIG/MAG 400 Amp.



These torches are characterized by the following features:

- Ergonomic and technically advanced, 100% reliable
- Globally recognized top quality
- New ergonomically shaped handles for best accessibility and fatigue-free work
- Handle with ball joint for motion flexibility - excellent handling
- Optimal torch cooling over long periods
- Best ignition even with thin wires
- Versatility due to the Euro Central Adapter System
- Different handles available upon request
- Swan Neck in 45°

Model	ME400W
Maximum current CO ₂	400 A
Duty Cycle CO ₂	80%
Maximum current Argon R.G.M.	320 A
Duty Cycle Argon	80%
Wire Ø	0.8 - 2.4 mm

Type	Item no. - 3.0m	Item no. - 3.5m	Item no. - 4.0m	Item no. - 4.5m
ME400W-N Spring Pins	117173	117174	117175	117176

Different lengths available upon request

Replacement Parts:

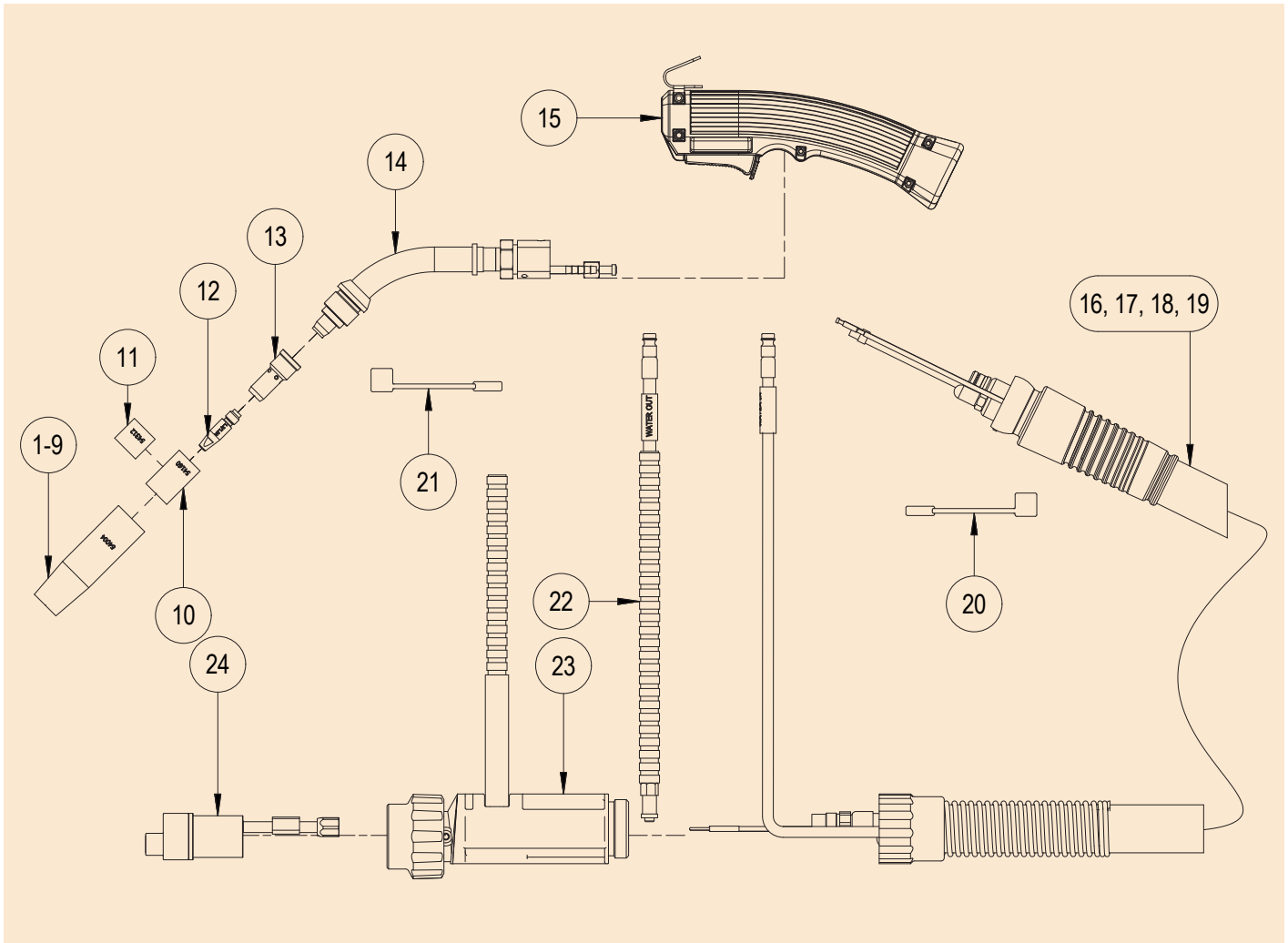

Pos.	Item no.	Description	pcs.
1	54004	Nozzle spray HD ID 15mm	1
2	54006	Nozzle dip, long conical ID 15mm	1
3	54003	Nozzle dip, short conical ID 15.5mm	1
4	54011	Nozzle spray HD long ID 15mm	1
5	54007	Nozzle parallel HD ID 19.2mm	1
6	54005	Nozzle spot ID 22mm	1
7	54022	Nozzle pulse HD ID 15mm	1
8	54028	Nozzle spray small bore ID 10mm	1
9	54008	Nozzle spray small bore ID 13mm	1
10	54160	Nozzle insulator Ø19xØ16.5 x 30.5	5
11	54312	Nozzle insulator Ø19xØ16.5 x 18	5
12	57838	Contact tip M8 copsisl 1.0 / 0.8 aluminium round	10
13	54099	Gas diffuser M8	5

Pos.	Item no.	Description	pcs.
14	54100	Swan neck ME400W - 45°	1
15 ¹	117692	Handle kit size 1-3 with ball joint	1
16	117887	Hose cable assembly ME400W, spring pins, ball joint, 3.0m	1
17	117888	Hose cable assembly ME400W, spring pins, ball joint, 3.5m	1
18	117889	Hose cable assembly ME400W, spring pins, ball joint, 4.0m	1
19	117890	Hose cable assembly ME400W, spring pins, ball joint, 4.5m	1
20	115822	Water cap, blue	1
21	115823	Water cap, red	1
22	76054	Water outlet hose compl.	1
23	117695	Central adapter support, water cooled, kit	1
24	57141	2-pin central adaptor, spring pins ME400W - ME600W	1

¹ = for other handle kits refer to datasheet: Handle kits

Gas Diffuser



54099 M8

Liners Hard Wire



57195 - 3.0m 0.8 - 1.2 blue, steel wire
57196 - 3.5m 0.8 - 1.2 blue, steel wire
57197 - 4.0m 0.8 - 1.2 blue, steel wire
57198 - 4.5m 0.8 - 1.2 blue, steel wire
57261 - 3.0m 1.4 - 2.0 red, steel wire
57262 - 3.5m 1.4 - 2.0 red, steel wire
57263 - 4.0m 1.4 - 2.0 red, steel wire
57264 - 4.5m 1.4 - 2.0 red, steel wire

57281 - 3.0m 1.2 - 1.4 grey, steel wire
57282 - 3.5m 1.2 - 1.4 grey, steel wire
57283 - 4.0m 1.2 - 1.4 grey, steel wire
57284 - 4.5m 1.2 - 1.4 grey, steel wire
57381 - 3.0m 2.0 - 3.2 yellow, steel wire
57382 - 3.5m 2.0 - 3.2 yellow, steel wire
57383 - 4.0m 2.0 - 3.2 yellow, steel wire
57384 - 4.5m 2.0 - 3.2 yellow, steel wire

Liners Soft Wire



57155 - 3.0m 0.8 - 1.0 black, aluminium wire
57156 - 3.5m 0.8 - 1.0 black, aluminium wire
57157 - 4.0m 0.8 - 1.0 black, aluminium wire
57158 - 4.5m 0.8 - 1.0 black, aluminium wire
57250 - 3.0m 1.2 - 2.0 red, aluminium wire
57251 - 3.5m 1.2 - 2.0 red, aluminium wire
57252 - 4.0m 1.2 - 2.0 red, aluminium wire
57253 - 4.5m 1.2 - 2.0 red, aluminium wire

57200 - 3.0m 1.0 - 1.2 blue, aluminium wire
57201 - 3.5m 1.0 - 1.2 blue, aluminium wire
57202 - 4.0m 1.0 - 1.2 blue, aluminium wire
57203 - 4.5m 1.0 - 1.2 blue, aluminium wire
114706 - 3.0m 2.0 - 3.2 yellow, aluminium wire
114707 - 3.5m 2.0 - 3.2 yellow, aluminium wire
114708 - 4.0m 2.0 - 3.2 yellow, aluminium wire
114709 - 4.5m 2.0 - 3.2 yellow, aluminium wire

Type

Contact Tips











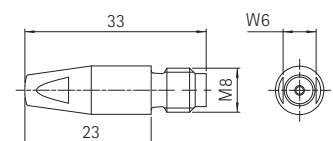
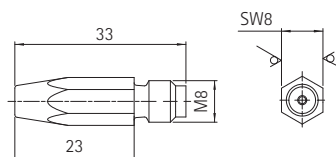



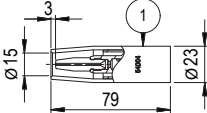

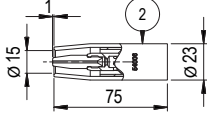

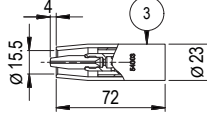

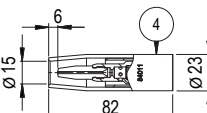
Contact Tip M8 hexagonal (pure copper)
MOQ = 10 pcs.

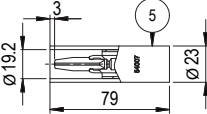
57800 - M8 0.8 hexagonal
57801 - M8 0.9 hexagonal
57802 - M8 1.0 / 0.8 aluminium hexagonal
57803 - M8 1.2 / 1.0 aluminium hexagonal
57804 - M8 1.4 / 1.2 aluminium hexagonal
57805 - M8 1.6 / 1.4 aluminium hexagonal
57834 - M8 1.8 / 1.6 aluminium hexagonal
57806 - M8 2.0 / 1.8 aluminium hexagonal
57807 - M8 2.4 / 2.0 aluminium hexagonal
57813 - M8 2.8 / 2.4 aluminium hexagonal
57815 - M8 3.2 / 2.8 aluminium hexagonal

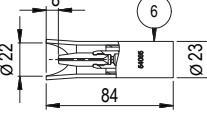
Contact Tip M8 round, copsis (copper-silver)
MOQ = 10 pcs.

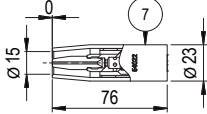
57835 - M8 copsis 0.8 round
57836 - M8 copsis 0.9 round
57837 - M8 copsis 1.0 / 0.8 aluminium round
57838 - M8 copsis 1.2 / 1.0 aluminium round
57839 - M8 copsis 1.4 / 1.2 aluminium round
57840 - M8 copsis 1.6 / 1.4 aluminium round
-
57841 - M8 copsis 2.0 / 1.8 aluminium round
57842 - M8 copsis 2.4 / 2.0 aluminium round
57843 - M8 copsis 2.8 / 2.4 aluminium round
57844 - M8 copsis 3.2 / 2.8 aluminium round

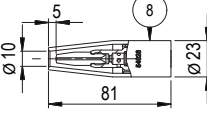

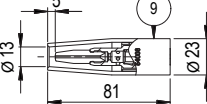
	Pos.	Item no.	Description
 	1	54004	Nozzle spray HD ID 15mm
 	2	54006	Nozzle dip, long conical ID 15mm
 	3	54003	Nozzle dip, short conical ID 15.5mm
 	4	54011	Nozzle spray HD long ID 15mm
 	5	54007	Nozzle parallel HD ID 19.2mm
 	6	54005	Nozzle spot ID 22mm
 	7	54022	Nozzle pulse HD ID 15mm
 	8	54028	Nozzle spray small bore ID 10mm
 	9	54008	Nozzle spray small bore ID 13mm