



ME500A HEAVY DUTY GAS COOLED WELDING TORCHES MIG/MAG 500 Amp



These torches are characterized by the following features:

- Ergonomic and technically advanced, 100% reliable
- Globally recognized top quality
- New ergonomically shaped handles for best accessibility and fatigue-free work
- Handle with ball joint for motion flexibility - excellent handling
- Optimal torch cooling over long periods
- Best ignition even with thin wires
- Versatility due to the Euro Central Adapter System
- Different handles available upon request
- Swan Neck in 180° / 45°

Model	ME500A
Maximum current CO ₂	500 A
Duty Cycle CO ₂	60%
Maximum current Argon R.G.M.	335 A
Duty Cycle Argon	60%
Wire Ø	0.8 - 2.4 mm

Type	Item no. - 3.0m	Item no. - 3.5m	Item no. - 4.0m	Item no. - 4.5m
ME500A-N Spring Pins	116743	116744	116745	116746

Different lengths available upon request

Replacement Parts:

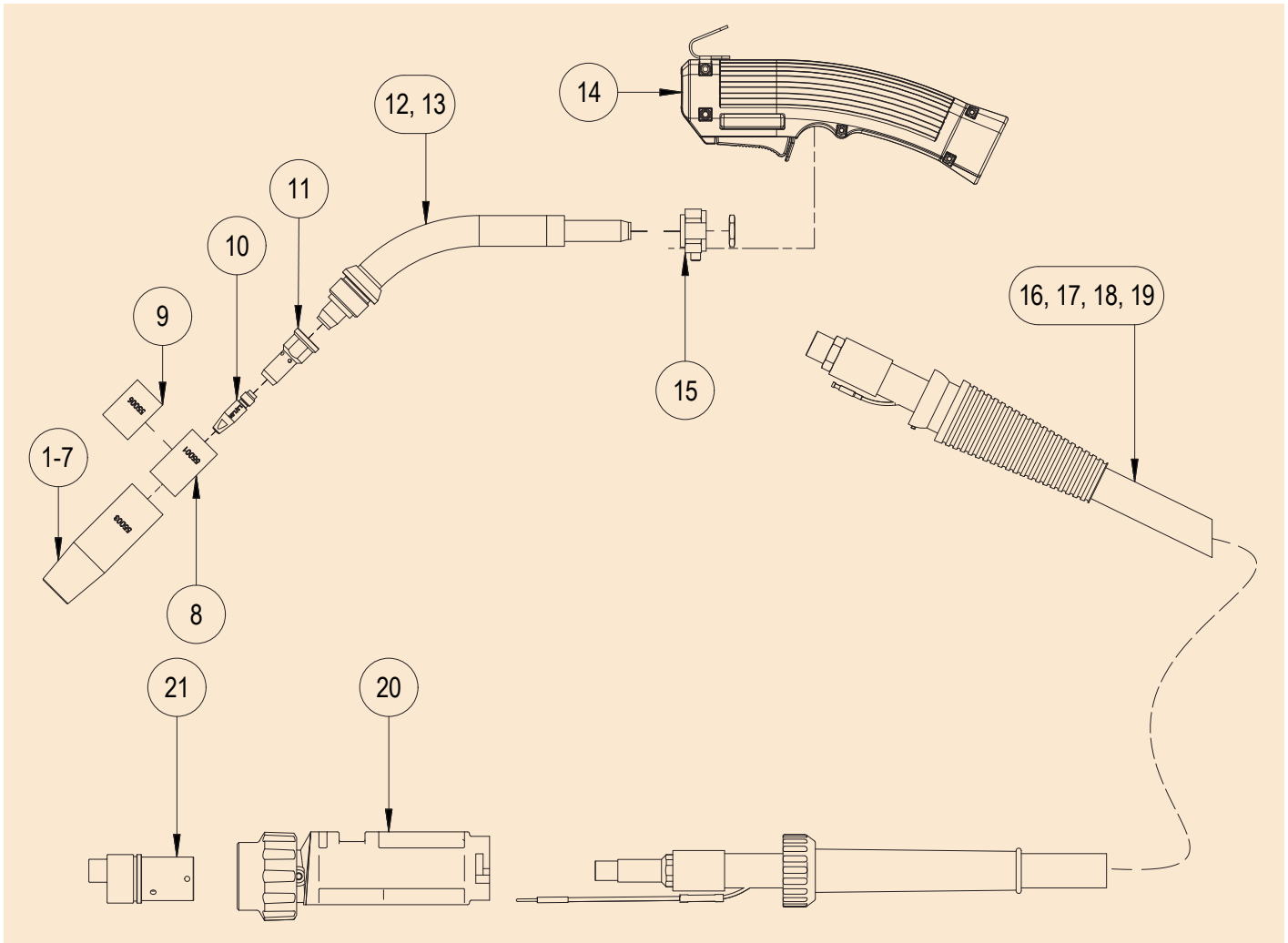

Pos.	Item no.	Description	pcs.
1	55003	Nozzle spray HD ID 17mm	1
2	55026	Nozzle spray HD short	1
3	55008	Nozzle pulse HD ID 17mm	1
4	55011	Gas nozzle - parallel	1
5	55009	Nozzle spray HD long	1
6	55005	Nozzle spray small bore ID 10.5mm	1
7	55004	Nozzle spot HD	1
8	55001	Nozzle insulator Ø 22 x 19 L = 37	5
9	55006	Nozzle insulator Ø 22 x 19 L = 30.5	5
10	57838	Contact tip M8 copsil 1.0 / 0.8 aluminium round	10
11	55002	Gas diffuser M8 ME500A	1
12	55020	Swan neck ME500A - 45° compl.	1
13	55021	Swan neck ME500A - 180° compl.	1

Pos.	Item no.	Description	pcs.
14 ¹	117693	Handle kit size 4-6 with ball joint	1
15	55016	Swan neck holder ME500A	1
16	117524	Hose cable assembly ME500A, spring pins, ball joint, 3.0m	1
17	117525	Hose cable assembly ME500A, spring pins, ball joint, 3.5m	1
18	117526	Hose cable assembly ME500A, spring pins, ball joint, 4.0m	1
19	117527	Hose cable assembly ME500A, spring pins, ball joint, 4.5m	1
20	117757	Central adapter support, gas cooled, kit	1
21	57113	2-Pins central adapter M12 x 1 compl. spring pins	1

¹ = for other handle kits refer to data sheet: Handle kits

Gas Diffuser

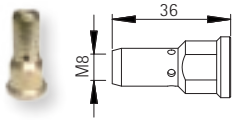

55002 M8

Liners Hard Wire



57195 - 3.0m 0.8 - 1.2 blue, steel wire

57196 - 3.5m 0.8 - 1.2 blue, steel wire

57197 - 4.0m 0.8 - 1.2 blue, steel wire

57198 - 4.5m 0.8 - 1.2 blue, steel wire

57261 - 3.0m 1.4 - 2.0 red, steel wire

57262 - 3.5m 1.4 - 2.0 red, steel wire

57263 - 4.0m 1.4 - 2.0 red, steel wire

57264 - 4.5m 1.4 - 2.0 red, steel wire

57281 - 3.0m 1.2 - 1.4 grey, steel wire

57282 - 3.5m 1.2 - 1.4 grey, steel wire

57283 - 4.0m 1.2 - 1.4 grey, steel wire

57284 - 4.5m 1.2 - 1.4 grey, steel wire

57381 - 3.0m 2.0 - 3.2 yellow, steel wire

57382 - 3.5m 2.0 - 3.2 yellow, steel wire

57383 - 4.0m 2.0 - 3.2 yellow, steel wire

57384 - 4.5m 2.0 - 3.2 yellow, steel wire

Liners Soft Wire



57155 - 3.0m 0.8 - 1.0 black, aluminium wire

57156 - 3.5m 0.8 - 1.0 black, aluminium wire

57157 - 4.0m 0.8 - 1.0 black, aluminium wire

57158 - 4.5m 0.8 - 1.0 black, aluminium wire

57250 - 3.0m 1.2 - 2.0 red, aluminium wire

57251 - 3.5m 1.2 - 2.0 red, aluminium wire

57252 - 4.0m 1.2 - 2.0 red, aluminium wire

57253 - 4.5m 1.2 - 2.0 red, aluminium wire

57200 - 3.0m 1.0 - 1.2 blue, aluminium wire

57201 - 3.5m 1.0 - 1.2 blue, aluminium wire

57202 - 4.0m 1.0 - 1.2 blue, aluminium wire

57203 - 4.5m 1.0 - 1.2 blue, aluminium wire

114706 - 3.0m 2.0 - 3.2 yellow, aluminium wire

114707 - 3.5m 2.0 - 3.2 yellow, aluminium wire

114708 - 4.0m 2.0 - 3.2 yellow, aluminium wire

114709 - 4.5m 2.0 - 3.2 yellow, aluminium wire

Type

Contact Tips



Contact Tip M8 hexagonal (pure copper)
MOQ = 10 pcs.

57800 - M8 0.8 hexagonal

57801 - M8 0.9 hexagonal

57802 - M8 1.0 / 0.8 aluminium hexagonal

57803 - M8 1.2 / 1.0 aluminium hexagonal

57804 - M8 1.4 / 1.2 aluminium hexagonal

57805 - M8 1.6 / 1.4 aluminium hexagonal

57834 - M8 1.8 / 1.6 aluminium hexagonal

57806 - M8 2.0 / 1.8 aluminium hexagonal

57807 - M8 2.4 / 2.0 aluminium hexagonal

Contact Tip M8 round, copsil (copper-silver)
MOQ = 10 pcs.

57835 - M8 copsil 0.8 round

57836 - M8 copsil 0.9 round

57837 - M8 copsil 1.0 / 0.8 aluminium round

57838 - M8 copsil 1.2 / 1.0 aluminium round

57839 - M8 copsil 1.4 / 1.2 aluminium round









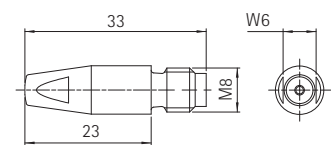
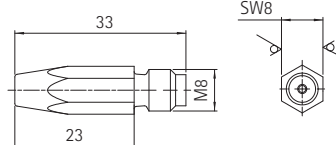

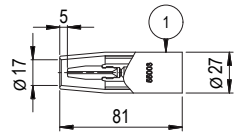

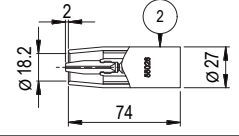
57840 - M8 copsil 1.6 / 1.4 aluminium round

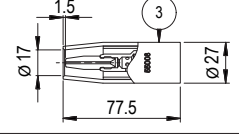
-

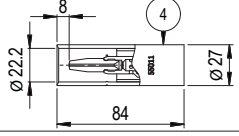
57841 - M8 copsil 2.0 / 1.8 aluminium round

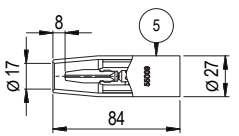
57842 - M8 copsil 2.4 / 2.0 aluminium round

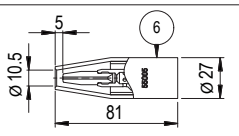

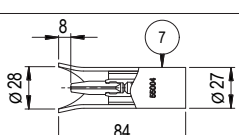
	Pos.	Item no.	Description
 	1	55003	Nozzle spray HD ID 17mm
 	2	55026	Nozzle spray HD short
 	3	55008	Nozzle pulse HD ID 17mm
 	4	55011	Gas nozzle - parallel
 	5	55009	Nozzle spray HD long
 	6	55005	Nozzle spray small bore ID 10.5mm
 	7	55004	Nozzle spot HD

- Nozzle insulator item no.: 55001
 use for Gas Nozzle item no.: 55003, 55026, 55008, 55011, 55009, 55004

- Nozzle insulator item no.: 55006
 use for Gas Nozzle item no.: 55005