



ME400A HEAVY DUTY GAS COOLED WELDING TORCHES MIG/MAG 400 Amp



These torches are characterized by the following features:

- Ergonomic and technically advanced, 100% reliable
- Globally recognized top quality
- New ergonomically shaped handles for best accessibility and fatigue-free work
- Handle with ball joint for motion flexibility - excellent handling
- Optimal torch cooling over long periods
- Best ignition even with thin wires
- Versatility due to the Euro Central Adapter System
- Different handles available upon request
- Swan Neck in 180° / 45°

Model	ME400A
Maximum current CO ₂	400 A
Duty Cycle CO ₂	60%
Maximum current Argon R.G.M.	260 A
Duty Cycle Argon	60%
Wire Ø	0.8 - 2.0 mm

Type	Item no. - 3.0m	Item no. - 3.5m	Item no. - 4.0m	Item no. - 4.5m
ME400A-N Spring Pins	116735	116736	116737	116738

Different lengths available upon request

Replacement Parts:

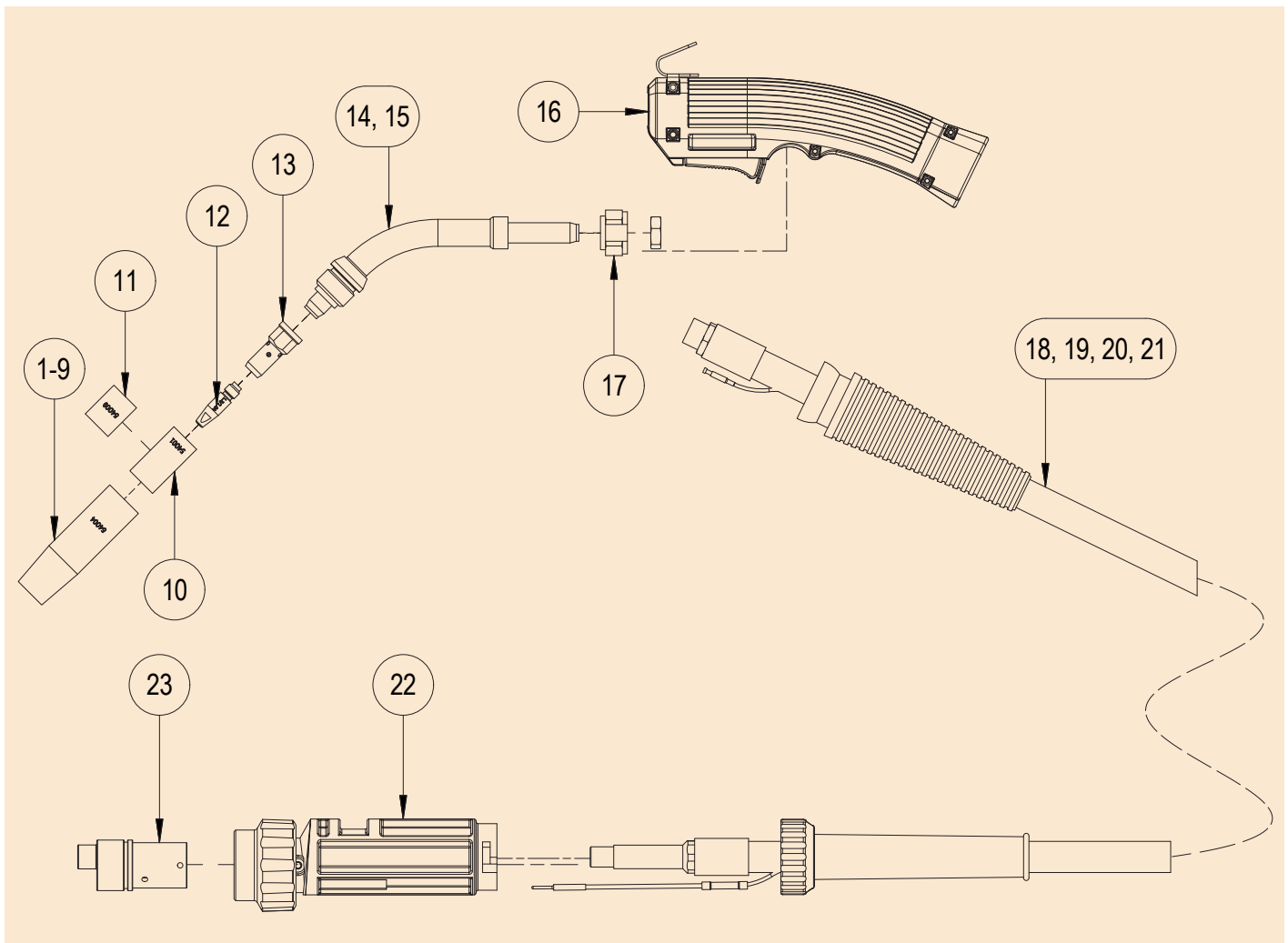

Pos.	Item no.	Description	pcs.
1	54004	Nozzle spray HD ID 15mm	1
2	54006	Nozzle dip long conical ID 15mm	1
3	54003	Nozzle dip short conical ID 15.5mm	1
4	54022	Nozzle pulse HD ID 15mm	1
5	54008	Nozzle spray small bore ID 13mm	1
6	54028	Nozzle spray small bore ID 10mm	1
7	54011	Nozzle spray HD long ID 15mm	1
8	54007	Nozzle parallel HD ID 19.2mm	1
9	54005	Nozzle spot ID 22mm	1
10	54001	Nozzle insulator Ø 19 x 16.5 L = 37	5
11	54009	Nozzle insulator Ø 19 x 16.5 L = 24	5
12	57838	Contact tip M8 copsil 1.0 / 0.8 aluminium round	10
13	54002	Gas diffuser M8	1

Pos.	Item no.	Description	pcs.
14	54017	Swan neck ME400A - 45° compl.	1
15	54019	Swan neck ME400A - 180° compl.	1
16 ¹	117693	Handle kit size 4-6 with ball joint	1
17	54016	Swan neck holder	1
18	117381	Hose cable assembly ME400/395A, spring pins, ball joint, 3.0m	1
19	117382	Hose cable assembly ME400/395A, spring pins, ball joint, 3.5m	1
20	117383	Hose cable assembly ME400/395A, spring pins, ball joint, 4.0m	1
21	117384	Hose cable assembly ME400/395A, spring pins, ball joint, 4.5m	1
22	117757	Central adapter support, gas cooled, kit	1
23	57113	2-Pins central adapter M12 x 1 compl. spring pins	1

¹ = for other handle kits refer to data sheet: Handle kits

Gas Diffuser

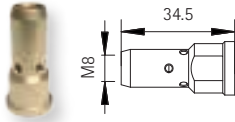

54002 M8

Liners Hard Wire



- 57195 - 3.0m 0.8 - 1.2 blue, steel wire
- 57196 - 3.5m 0.8 - 1.2 blue, steel wire
- 57197 - 4.0m 0.8 - 1.2 blue, steel wire
- 57198 - 4.5m 0.8 - 1.2 blue, steel wire

- 57281 - 3.0m 1.2 - 1.4 grey, steel wire
- 57282 - 3.5m 1.2 - 1.4 grey, steel wire
- 57283 - 4.0m 1.2 - 1.4 grey, steel wire
- 57284 - 4.5m 1.2 - 1.4 grey, steel wire

- 57261 - 3.0m 1.4 - 2.0 red, steel wire
- 57262 - 3.5m 1.4 - 2.0 red, steel wire
- 57263 - 4.0m 1.4 - 2.0 red, steel wire
- 57264 - 4.5m 1.4 - 2.0 red, steel wire

Liners Soft Wire



- 57155 - 3.0m 0.8 - 1.0 black, aluminium wire
- 57156 - 3.5m 0.8 - 1.0 black, aluminium wire
- 57157 - 4.0m 0.8 - 1.0 black, aluminium wire
- 57158 - 4.5m 0.8 - 1.0 black, aluminium wire

- 57200 - 3.0m 1.0 - 1.2 blue, aluminium wire
- 57201 - 3.5m 1.0 - 1.2 blue, aluminium wire
- 57202 - 4.0m 1.0 - 1.2 blue, aluminium wire
- 57203 - 4.5m 1.0 - 1.2 blue, aluminium wire

- 57250 - 3.0m 1.2 - 2.0 red, aluminium wire
- 57251 - 3.5m 1.2 - 2.0 red, aluminium wire
- 57252 - 4.0m 1.2 - 2.0 red, aluminium wire
- 57253 - 4.5m 1.2 - 2.0 red, aluminium wire

Type

Contact Tips











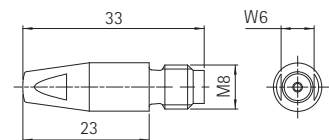
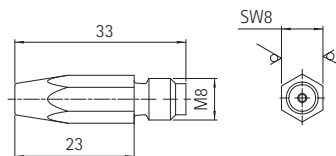



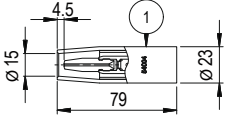

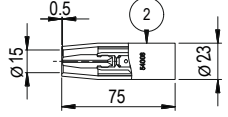

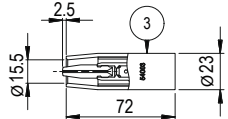

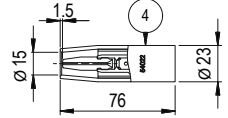
Contact Tip M8 hexagonal (pure copper)
MOQ = 10 pcs.

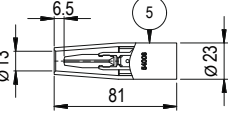
- 57800 - M8 0.8 hexagonal
- 57801 - M8 0.9 hexagonal
- 57802 - M8 1.0 / 0.8 aluminium hexagonal
- 57803 - M8 1.2 / 1.0 aluminium hexagonal
- 57804 - M8 1.4 / 1.2 aluminium hexagonal
- 57805 - M8 1.6 / 1.4 aluminium hexagonal
- 57834 - M8 1.8 / 1.6 aluminium hexagonal
- 57806 - M8 2.0 / 1.8 aluminium hexagonal

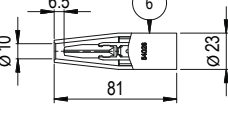
Contact Tip M8 round, copsil (copper-silver)
MOQ = 10 pcs.

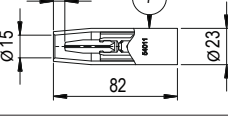
- 57835 - M8 copsil 0.8 round
- 57836 - M8 copsil 0.9 round
- 57837 - M8 copsil 1.0 / 0.8 aluminium round
- 57838 - M8 copsil 1.2 / 1.0 aluminium round
- 57839 - M8 copsil 1.4 / 1.2 aluminium round
- 57840 - M8 copsil 1.6 / 1.4 aluminium round
-
- 57841 - M8 copsil 2.0 / 1.8 aluminium round

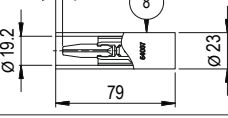

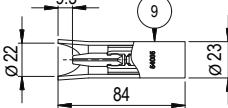
		Pos.	Item no.	Description
		1	54004	Nozzle spray HD ID 15mm
		2	54006	Nozzle dip, long conical ID 15mm
		3	54003	Nozzle dip, short conical ID 15.5mm
		4	54022	Nozzle pulse HD ID 15mm
		5	54008	Nozzle spray small bore ID 13mm
		6	54028	Nozzle spray small bore ID 10mm
		7	54011	Nozzle spray HD long ID 15mm
		8	54007	Nozzle parallel HD ID 19.2mm
		9	54005	Nozzle spot ID 22mm

- Nozzle insulator item no.: 54001
 use for Gas Nozzle item no.:
 54004, 54006, 54003, 54022, 54011, 54007, 54005

- Nozzle insulator item no.:54009
 use for Gas Nozzle item no.: 54008, 54028

Mechafin AG
 Chrummacherstr. 3 | CH-8954 Geroldswil | Switzerland
 Telephone +41 44 749 30 60 | Facsimile +41 44 749 30 70
 Mail info@mechafin.ch | Web www.mechafin.com

Mechafin Ltd
 Leigh Street | High Wycombe | Buckinghamshire | HP11 2QU UK
 Telephone +44 1494 441 110 | Facsimile +44 1494 473 049
 Mail enquiries@mechafin.co.uk | Web www.mechafin.com

All descriptions included in this catalogue are correct at the time of printing and may be subject to change and alternation from time to time. The contents used in this catalogue are property of Mechafin AG. This means, they are protected copyrights and/or trademarks or otherwise protected by ownership law.