



ME357A-360° HEAVY DUTY GAS COOLED WELDING TORCHES MIG/MAG 350 Amp.



These torches are characterized by the following features:

- Ergonomic and technically advanced, 100% reliable
- Globally recognized top quality
- New ergonomically shaped handles for best accessibility and fatigue-free work
- Handle with ball joint for motion flexibility - excellent handling
- Optimal torch cooling over long periods
- Best ignition even with thin wires
- Versatility due to the Euro Central Adapter System
- Different handles available upon request
- Swan Neck in 45°

Model	ME357A-N 360°
Maximum current CO ₂	350 A
Duty Cycle CO ₂	60%
Maximum current Argon R.G.M.	210 A
Duty Cycle Argon	60%
Wire Ø	0.6 - 1.6 mm

Type	Item no. - 3.0m	Item no. - 3.5m	Item no. - 4.0m	Item no. - 4.5m
ME357A-N 360° Spring Pins	116755	116756	116757	116758

Different lengths available upon request

Replacement Parts:

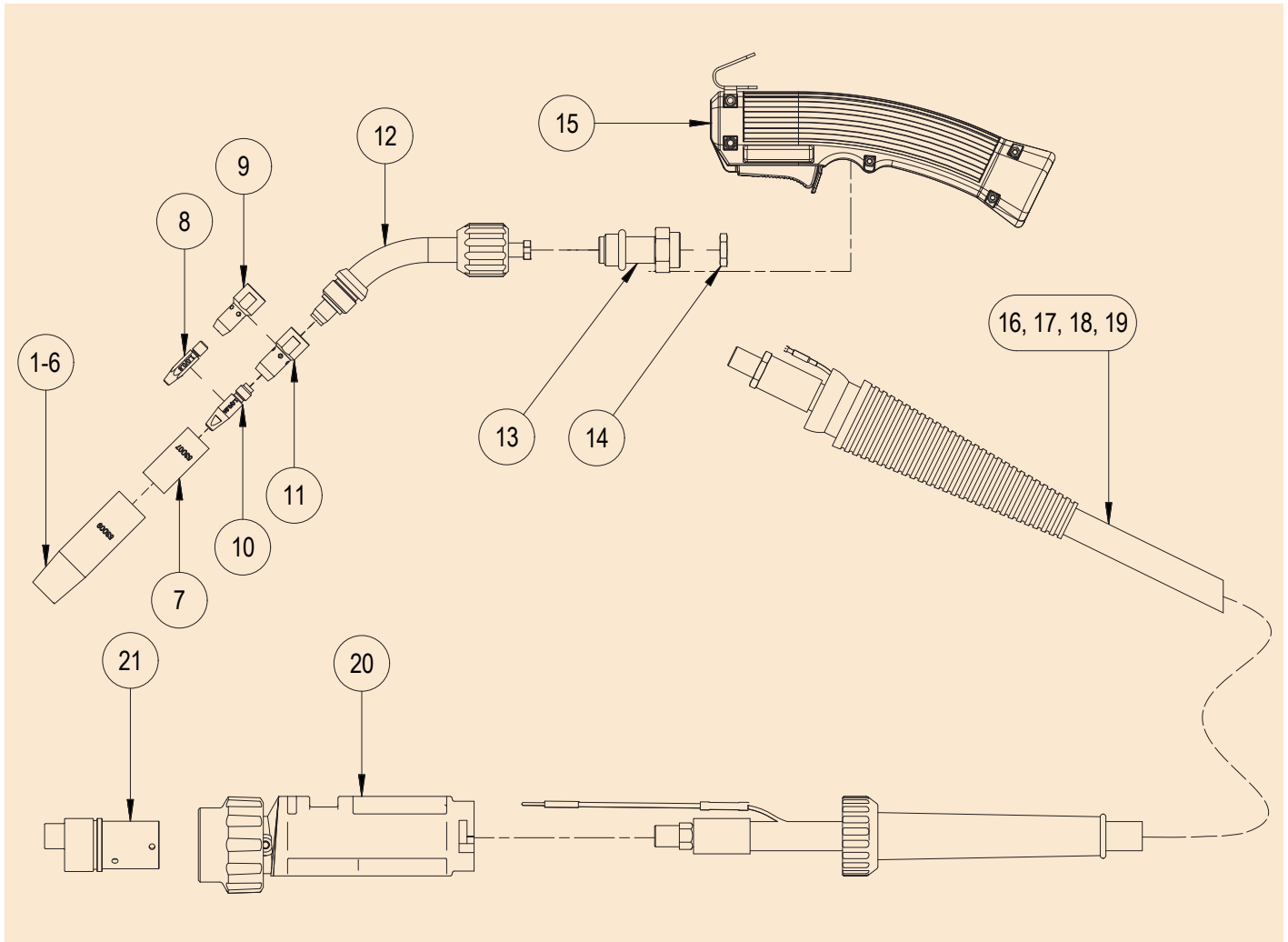





Pos.	Item no.	Description	psc.
1	53009	Nozzle spray HD	1
2	53004	Nozzle dip, long conical	1
2a	53157	Nozzle dip, long conical *	1
3	53003	Nozzle dip, short conical	1
3a	53156	Nozzle dip, short conical *	1
4	53015	Nozzle spray HD short	1
5	53005	Nozzle parallel	1
6	53006	Nozzle spot	1
7	53001	Spatter protection Ø 16.9 x 14.5 L = 36	5
8	57603	Contact tip M6 1.0 / 0.8 hexagonal	10
9	53002	Gas diffuser M6 ME300A-ME357A	5
10	57837	Contact tip M8 copsil 1.0 / 0.8 aluminium round	10
11	53008	Gas diffuser M8 ME300A-ME357A	5



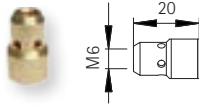
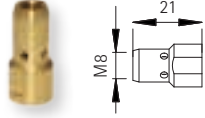





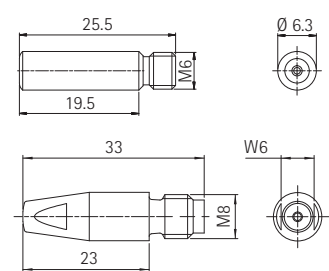
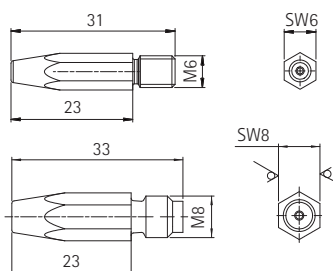

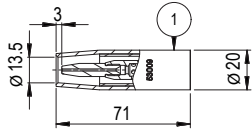

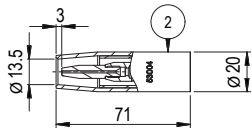

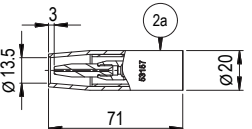
* no plating

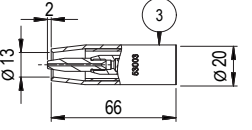
Pos.	Item no.	Description	psc.
12	53702	Swan neck ME357A - 45° compl.	1
13	54074	Swan neck holder ME397A	1
14	54012	Swan neck lock nut	1
15 ¹	117692	Handle kit size 1-3 with ball joint	1
16	117766	Hose cable assembly ME357A, spring pins, ball joint, 3.0m	1
17	117767	Hose cable assembly ME357A, spring pins, ball joint, 3.5m	1
18	117768	Hose cable assembly ME357A, spring pins, ball joint, 4.5m	1
19	117769	Hose cable assembly ME357A, spring pins, ball joint, 4.0m	1
20	117757	Central adapter support, gas cooled, kit	1
21	57113	2-Pins central adapter M12 x 1 compl. spring pins	1

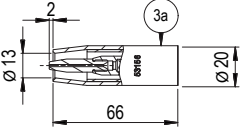
¹ = for other handle kits refer to data sheet: Handle kits

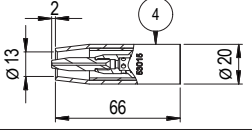
<p>Gas Diffuser</p>	<p>53002 M6</p> 	<p>53008 M8</p> 
<p>Liners Hard Wire</p> 	<p>57195 - 3.0m 0.8 - 1.2 blue, steel wire 57196 - 3.5m 0.8 - 1.2 blue, steel wire 57197 - 4.0m 0.8 - 1.2 blue, steel wire 57198 - 4.5m 0.8 - 1.2 blue, steel wire</p> <p>57261 - 3.0m 1.4 - 2.0 red, steel wire 57262 - 3.5m 1.4 - 2.0 red, steel wire 57263 - 4.0m 1.4 - 2.0 red, steel wire 57264 - 4.5m 1.4 - 2.0 red, steel wire</p>	<p>57281 - 3.0m 1.2 - 1.4 grey, steel wire 57282 - 3.5m 1.2 - 1.4 grey, steel wire 57283 - 4.0m 1.2 - 1.4 grey, steel wire 57284 - 4.5m 1.2 - 1.4 grey, steel wire</p>
<p>Liners Soft Wire</p> 	<p>57155 - 3.0m 0.8 - 1.0 black, aluminium wire 57156 - 3.5m 0.8 - 1.0 black, aluminium wire 57157 - 4.0m 0.8 - 1.0 black, aluminium wire 57158 - 4.5m 0.8 - 1.0 black, aluminium wire</p> <p>57250 - 3.0m 1.2 - 2.0 red, aluminium wire 57251 - 3.5m 1.2 - 2.0 red, aluminium wire 57252 - 4.0m 1.2 - 2.0 red, aluminium wire 57253 - 4.5m 1.2 - 2.0 red, aluminium wire</p>	<p>57200 - 3.0m 1.0 - 1.2 blue, aluminium wire 57201 - 3.5m 1.0 - 1.2 blue, aluminium wire 57202 - 4.0m 1.0 - 1.2 blue, aluminium wire 57203 - 4.5m 1.0 - 1.2 blue, aluminium wire</p>
<p>Type</p> <p>Contact Tips</p> 	<p>Contact Tip M6 hexagonal (pure copper) MOQ = 10 pcs.</p> <p>57600 - M6 0.6 hexagonal 57601 - M6 0.8 hexagonal 57602 - M6 0.9 hexagonal 57603 - M6 1.0 / 0.8 hexagonal 57604 - M6 1.2 / 1.0 hexagonal 57605 - M6 1.4 / 1.2 hexagonal</p>	<p>Contact Tip M6 round, cospil (copper-silver) MOQ = 10 pcs.</p> <p>57950 - M6 cospil 0.6 round 57951 - M6 cospil 0.8 round 57952 - M6 cospil 0.9 round 57953 - M6 cospil 1.0 round 57954 - M6 cospil 1.2 round</p>
	<p>Contact Tip M8 hexagonal (pure copper) MOQ = 10 pcs.</p> <p>57800 - M8 0.8 hexagonal 57801 - M8 0.9 hexagonal 57802 - M8 1.0 / 0.8 aluminium hexagonal 57803 - M8 1.2 / 1.0 aluminium hexagonal 57804 - M8 1.4 / 1.2 aluminium hexagonal 57805 - M8 1.6 / 1.4 aluminium hexagonal</p>	<p>Contact Tip M8 round, cospil (copper-silver) MOQ = 10 pcs.</p> <p>57835 - M8 cospil 0.8 round 57836 - M8 cospil 0.9 round 57837 - M8 cospil 1.0 / 0.8 aluminium round 57838 - M8 cospil 1.2 / 1.0 aluminium round 57839 - M8 cospil 1.4 / 1.2 aluminium round 57840 - M8 cospil 1.6 / 1.4 aluminium round</p>

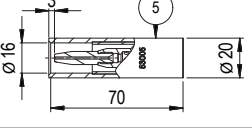

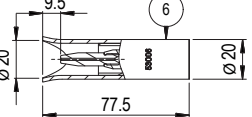
	Pos.	Item no.	Description
 	1	53009	Nozzle spray HD
 	2	53004	Nozzle dip, long conical
 	2a	53157	Nozzle dip, long conical *
 	3	53003	Nozzle dip, short conical
 	3a	53156	Nozzle dip, short conical *
 	4	53015	Nozzle spray HD short
 	5	53005	Nozzle parallel
 	6	53006	Nozzle spot

* no plating