

Motor 24VDC, 200rpm, 96.0watt

Left side with encoder 2x 60 pulse

Item number: 80141

Product weight (kg): 1.194 kg

Packing unit: 1



PRODUCT DESCRIPTION

Left side with encoder 2x 60 pulse



TECHNICAL CHARACTERISTICS

Speed (rpm):	200
Operating voltage DC (V):	24
Current (A):	4.0
Power (W):	96
Additional:	Encoder 2x 60 pulse
Operating voltage for encoder DC (V):	5
Version:	Left
Wire speed 30mm feedroll (m/min.):	18.85
Wire speed 37mm feedroll (m/min.):	23.25
Wire speed 40mm feedroll (m/min.):	25.13
Active cooling:	no
Suitable:	ME8900, ME9300, ME9500, ME9800, ME9900-4R, ME2000

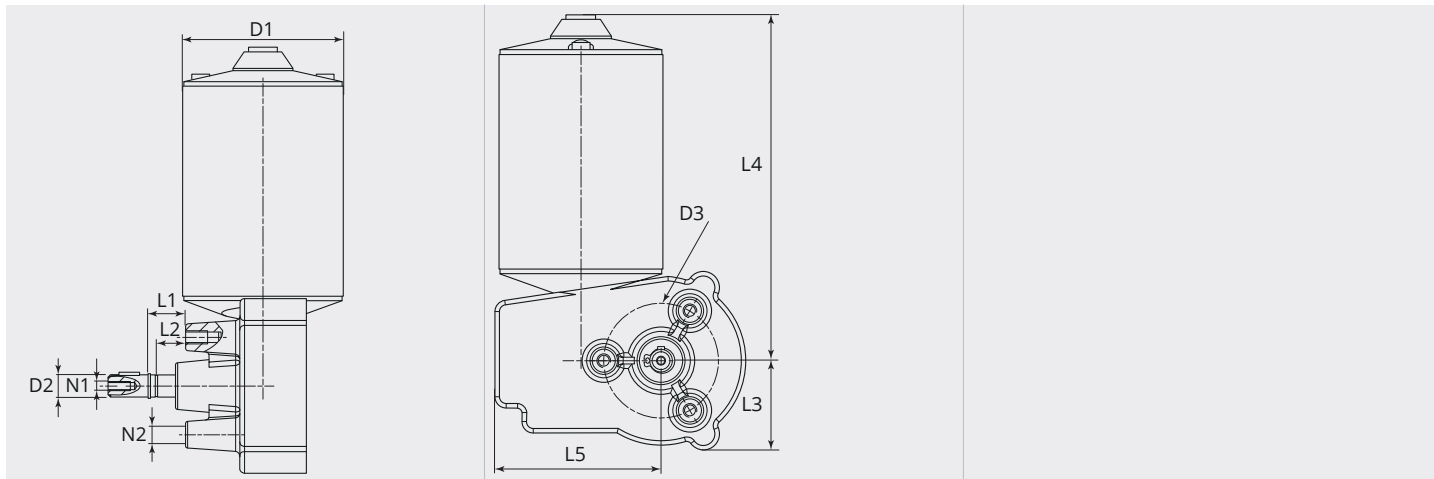
DIMENSIONAL DRAWING

DIMENSIONAL DRAWING

L1 (mm):	17.0
L3 (mm):	45.0
L4 (mm):	155.0
L5 (mm):	75.0
D1 (Ø):	71
D2 (Ø):	10-f6
D3 (Ø):	50.8
N1:	M4
N2:	M6