

Contact bush and lead 600mm

Applies for TIG adaptor

Item number:	75086
Product weight (kg):	0.007 kg
Packing unit:	1



PRODUCT DESCRIPTION

Applies for TIG adaptor

TECHNICAL CHARACTERISTICS

Terminal side:	Machine
Surface:	Tin plated

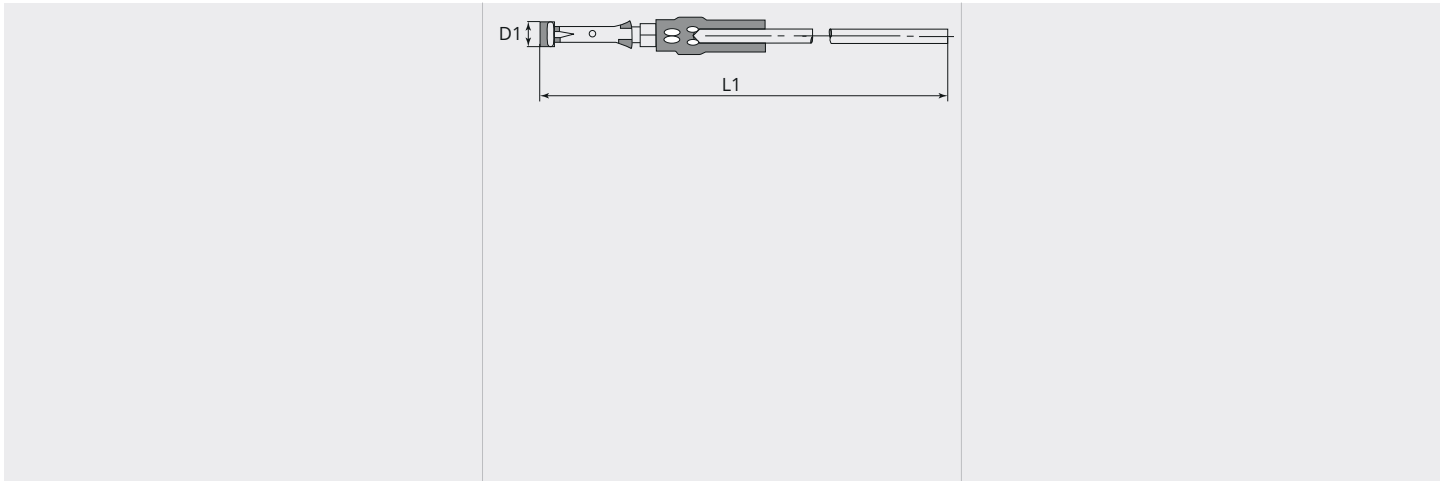
DIMENSIONAL DRAWING**DIMENSIONAL DRAWING**

L1 (mm):	600.0
D1 (Ø):	2.8