

Axle for gear adaptor

Applies for gear adaptor with bronze bush

Item number: 62358

Product weight (kg): 0.02 kg



PRODUCT DESCRIPTION

Applies for gear adaptor with bronze bush

TECHNICAL CHARACTERISTICS

Material: Steel

Surface: Black-finish

Suitable: ME9800

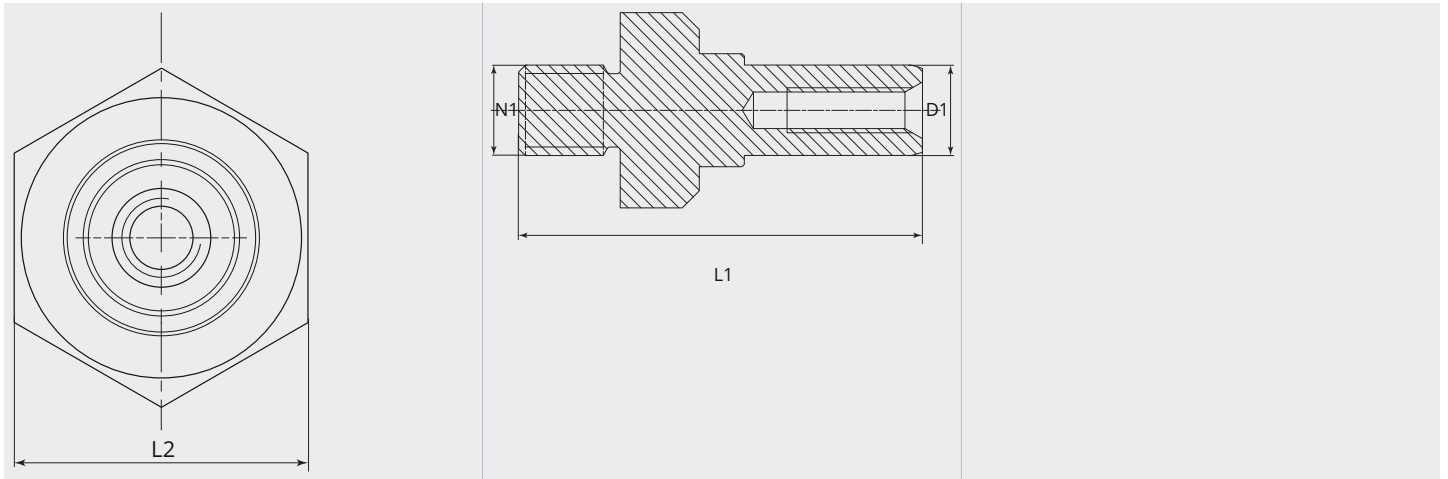
DIMENSIONAL DRAWING

DIMENSIONAL DRAWING

L1 (mm):	34.6
L2 (mm):	SW14
D1 (Ø):	8
N1:	M8