

Inlet Guide with steel liner for 0.8 - 1.2mm Wire

Applies for series: ME8700, ME8900, ME9300, ME9500, ME9900, ME2000-37, ME2000-40, ME2500-37, ME2500-40

Item number:	62148
Product weight (kg):	0.01 kg



PRODUCT DESCRIPTION

Applies for series: ME8700, ME8900, ME9300, ME9500, ME9900, ME2000-37, ME2000-40, ME2500-37, ME2500-40

TECHNICAL CHARACTERISTICS

Wire (mm):	0.8 - 1.2
Welding wire:	Steel / cored wire
Material:	Steel / plastic
Suitable:	ME8700, ME8900, ME9300, ME9500, ME9900, ME2000, ME2500

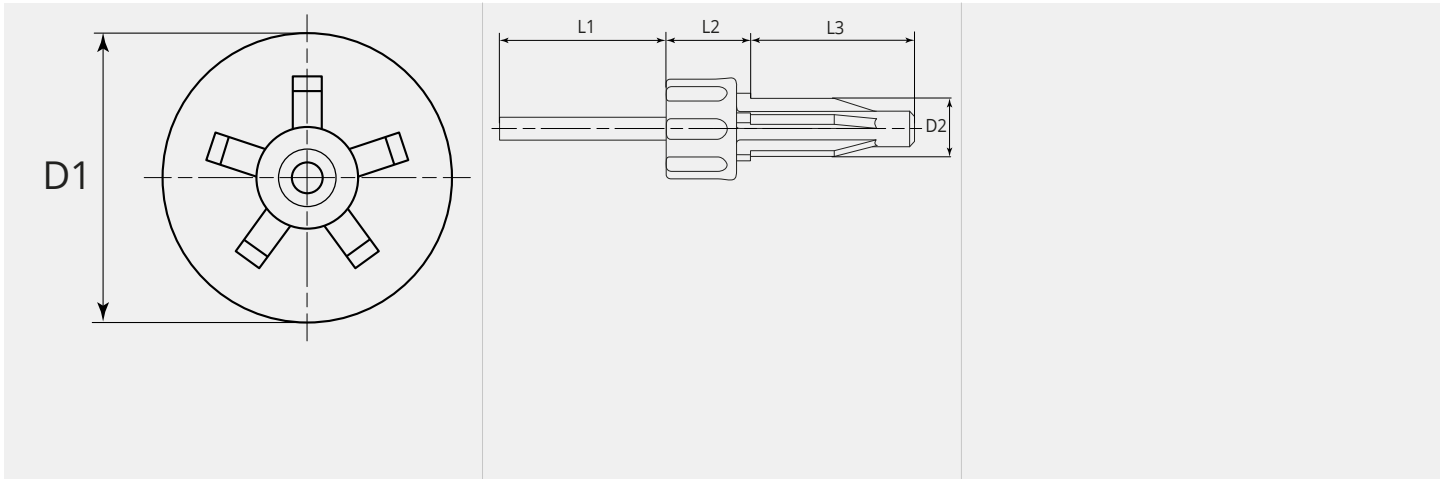
DIMENSIONAL DRAWING

DIMENSIONAL DRAWING

L1 (mm):	37.0
L2 (mm):	17.8
L3 (mm):	34.0
D1 (Ø):	20
D2 (Ø):	12.0