

Contact tip M8 round CuCrZr

Contact tip CuCrZr

Item number:	57837
Product weight (kg):	0.13 kg
Packing unit:	10



PRODUCT DESCRIPTION

Contact tip CuCrZr

TECHNICAL CHARACTERISTICS

Wire (mm):	1.0 / 0.8
Welding wire:	Steel / aluminium
Version:	Round
Material:	CuCrZr

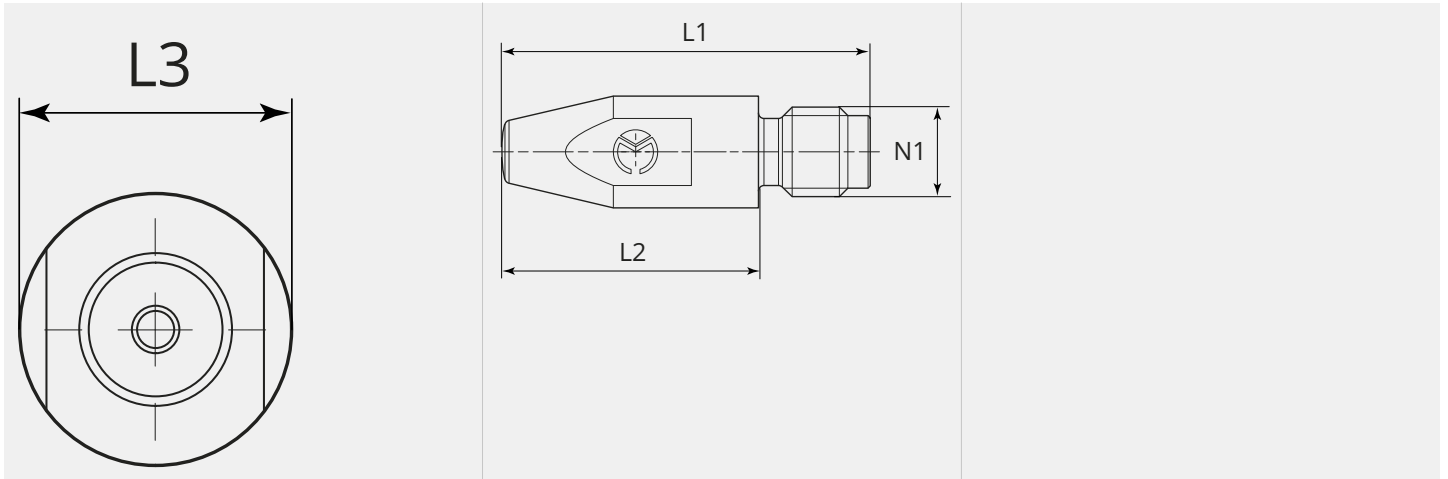
DIMENSIONAL DRAWING

DIMENSIONAL DRAWING

L1 (mm):	33.0
L2 (mm):	23.0
L3 (mm):	SW8
N1:	M8