

Contact tip M8 hex. copper

Contact tip native copper

Item number:	57805
Product weight (kg):	0.13 kg
Packing unit:	10

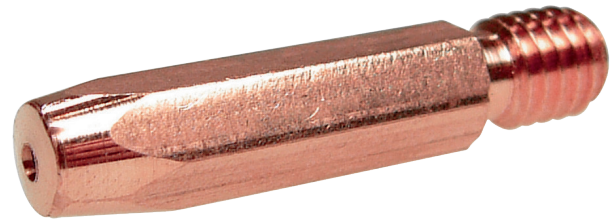

PRODUCT DESCRIPTION

Contact tip native copper

TECHNICAL CHARACTERISTICS

Wire (mm):	1.6 / 1.4
Welding wire:	Steel / aluminium
Version:	Hexagonal
Material:	Native copper

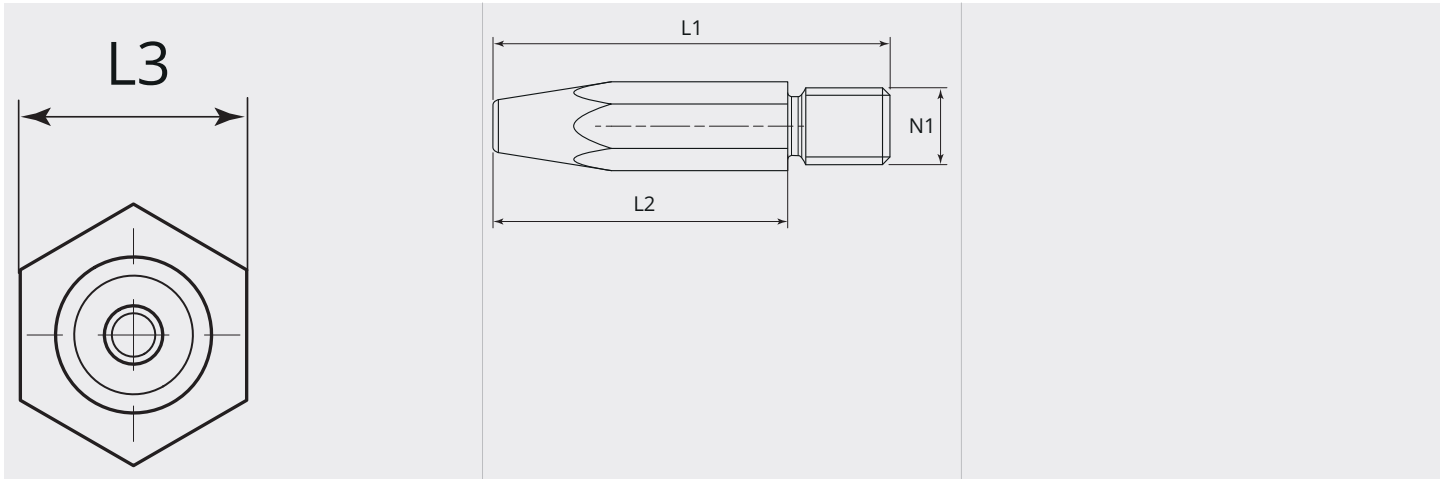
DIMENSIONAL DRAWING

DIMENSIONAL DRAWING

L1 (mm):	33.0
L2 (mm):	23.0
L3 (mm):	SW8
N1:	M8