

# Contact tip M8 hex. copper

Contact tip native copper

Item number:	57803
Product weight (kg):	0.14 kg
Packing unit:	10

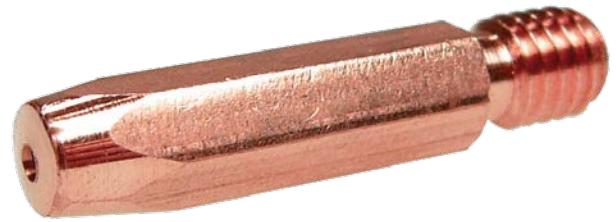

## PRODUCT DESCRIPTION

Contact tip native copper

## TECHNICAL CHARACTERISTICS

Wire (mm):	1.2 / 1.0
Welding wire:	Steel / aluminium
Version:	Hexagonal
Material:	Native copper

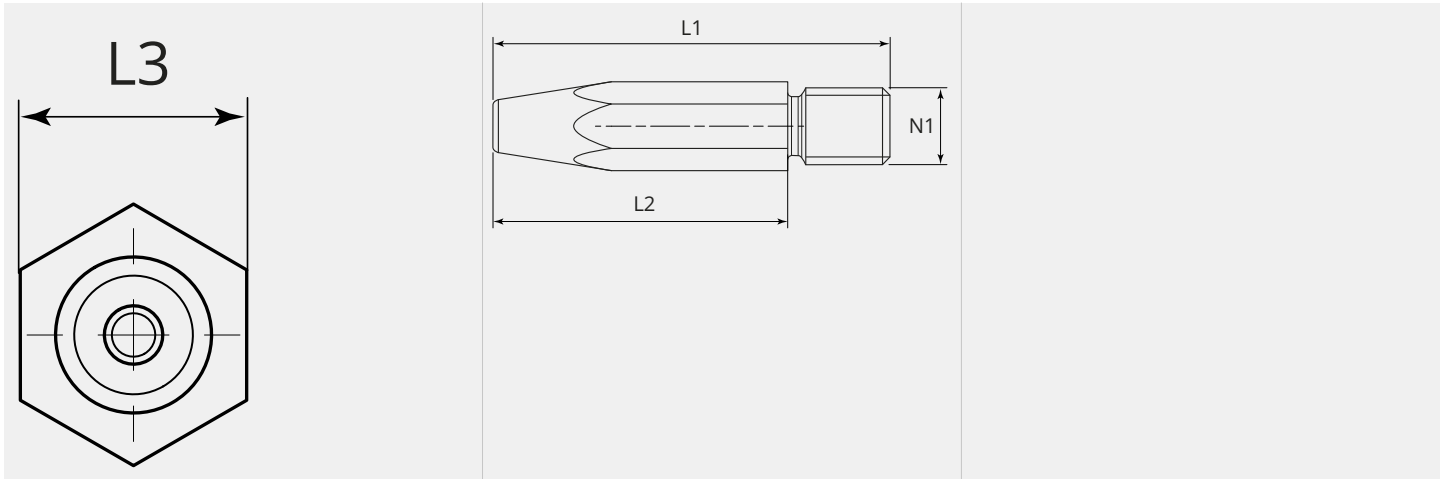
**DIMENSIONAL DRAWING**

**DIMENSIONAL DRAWING**

<b>L1 (mm):</b>	33.0
<b>L2 (mm):</b>	23.0
<b>L3 (mm):</b>	SW8
<b>N1:</b>	M8