

MIG/MAG Welding Gun Neck MER552WSC

Water cooled for 550A, Swan Neck Angle 45°, for 0.8 - 2.8 wire

Item number:	55610
Product weight (kg):	0.495 kg
Packing unit:	1



PRODUCT DESCRIPTION

Water cooled for 550A, Swan Neck Angle 45°, for 0.8 - 2.8 wire

TECHNICAL CHARACTERISTICS

Wire (mm):	0.8 - 2.8
Bending angle (°):	45
Max. current CO2 (A):	550
Duty Cycle CO2:	100
Max. current argon mixed gas (A):	380
Duty Cycle Argon mixed gas (%):	100
Cooling:	Water
Suitable:	MER552WSC

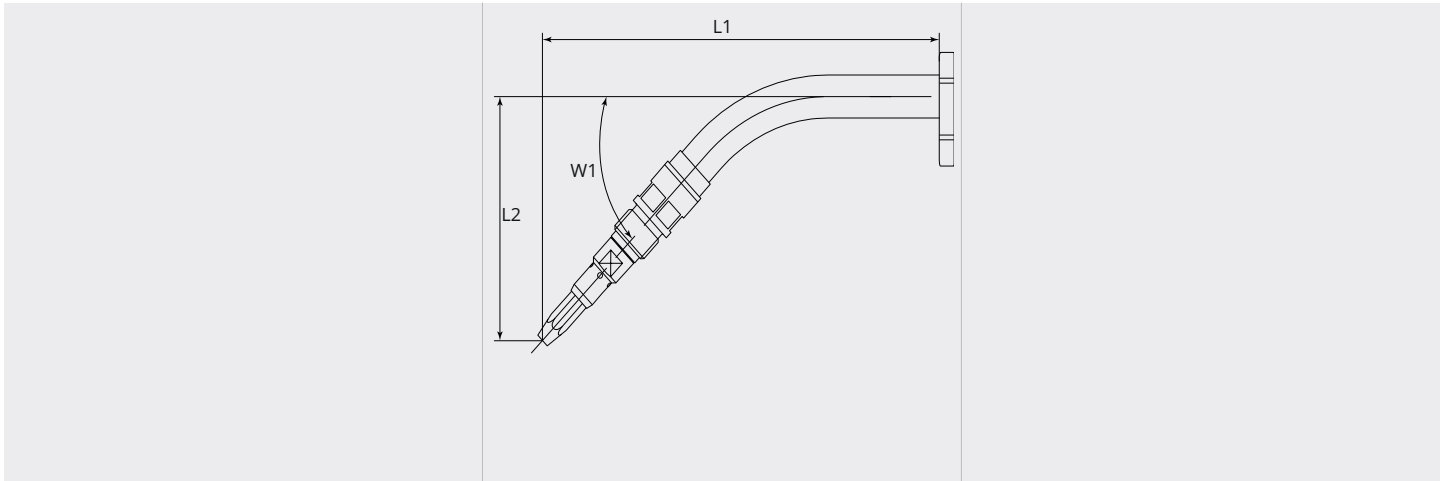
DIMENSIONAL DRAWING**DIMENSIONAL DRAWING**

L1 (mm):	171.0
L2 (mm):	96.5
W1 (°):	45.0