

MIG/MAG Welding Gun Neck MER452WSC

Water cooled for 450A, Swan Neck Angle 45°, for 0.8 - 2.4 wire

Item number:	54450
Product weight (kg):	0.422 kg
Packing unit:	1



PRODUCT DESCRIPTION

Water cooled for 450A, Swan Neck Angle 45°, for 0.8 - 2.4 wire

TECHNICAL CHARACTERISTICS

Wire (mm):	0.8 - 2.4
Bending angle (°):	45
Max. current CO2 (A):	450
Duty Cycle CO2:	100
Max. current argon mixed gas (A):	310
Duty Cycle Argon mixed gas (%):	100
Cooling:	Water
Suitable:	MER452WSC

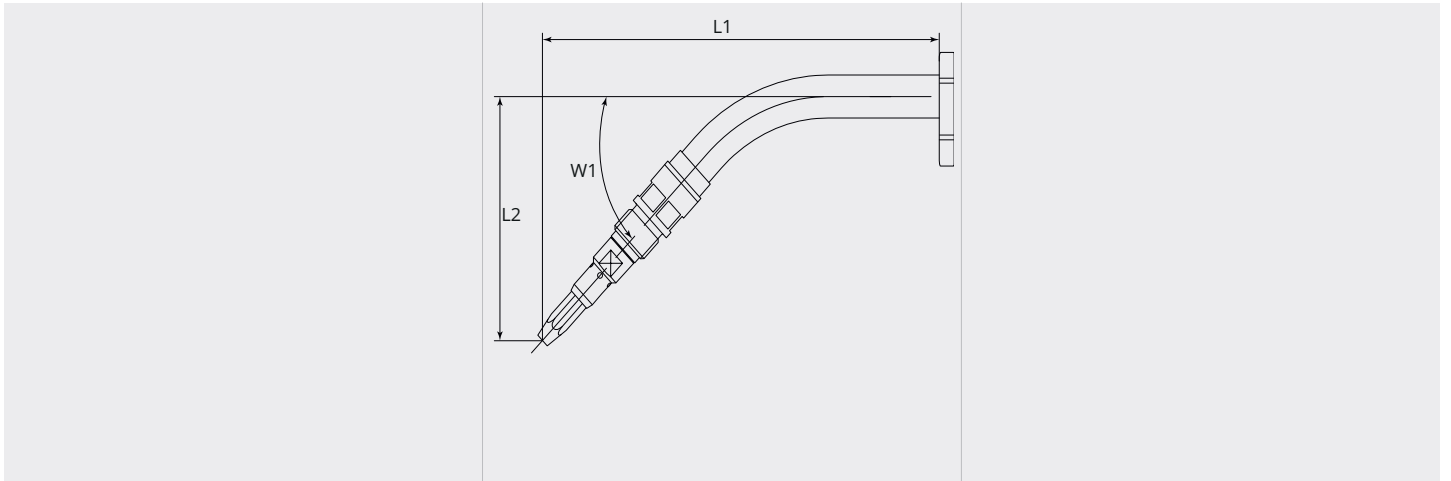
DIMENSIONAL DRAWING**DIMENSIONAL DRAWING**

L1 (mm):	171.0
L2 (mm):	96.5
W1 (°):	45.0