

MIG/MAG Welding Gun Neck MER352WSC

Water cooled for 350A, Swan Neck Angle 22.5°, for 0.8 - 2.0 wire

Item number:	53520
Product weight (kg):	0.387 kg
Packing unit:	1



PRODUCT DESCRIPTION

Water cooled for 350A, Swan Neck Angle 22.5°, for 0.8 - 2.0 wire

TECHNICAL CHARACTERISTICS

Wire (mm):	0.8 - 2.0
Bending angle (°):	22.5
Max. current CO2 (A):	350
Duty Cycle CO2:	100
Max. current argon mixed gas (A):	230
Duty Cycle Argon mixed gas (%):	100
Cooling:	Water
Suitable:	MER352WSC

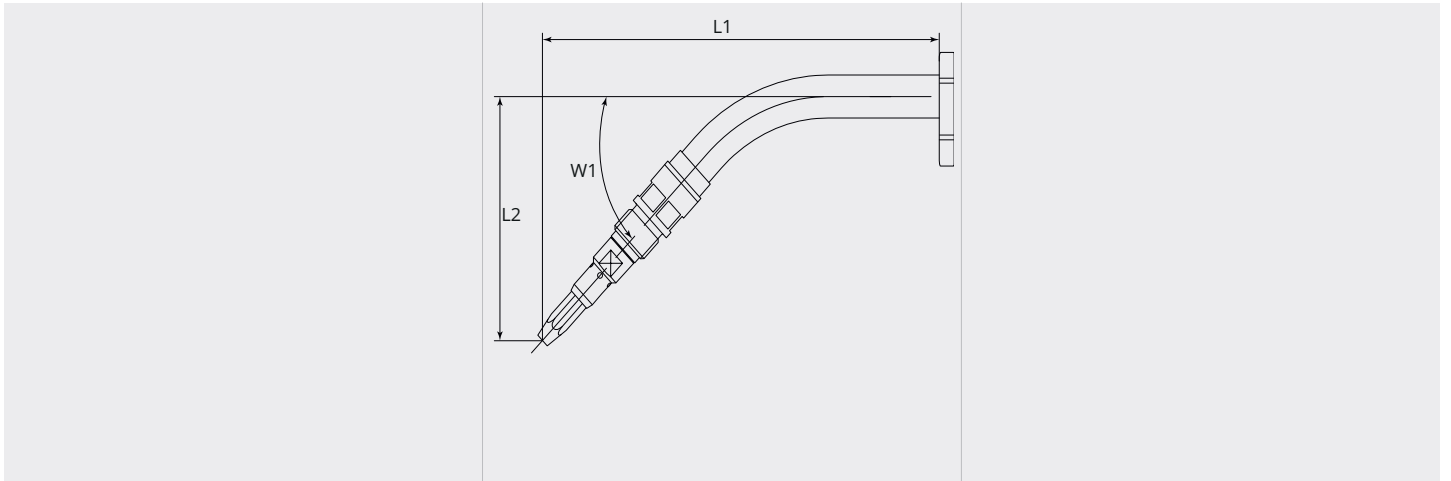
DIMENSIONAL DRAWING**DIMENSIONAL DRAWING**

L1 (mm):	198.5
L2 (mm):	47.0
W1 (°):	22.5