

# Feed Roll with keyway 40mm 2.4+3.2 for aluminium wire

Suitable for series: ME2500-40, ME2600-40

Item number:	140008
Product weight (kg):	0.119 kg
Packing unit:	1



## PRODUCT DESCRIPTION

Suitable for series: ME2500-40, ME2600-40

## TECHNICAL CHARACTERISTICS

<b>Wire (mm):</b>	2.4 + 3.2
<b>Welding wire:</b>	Aluminium
<b>Groove shape:</b>	U
<b>Characteristics of the groove:</b>	flat
<b>Type of setting:</b>	Keyway
<b>Material:</b>	Hardened steel
<b>Surface:</b>	Black-finish
<b>Arrangement Rolls:</b>	Bottom

## DIMENSIONAL DRAWING

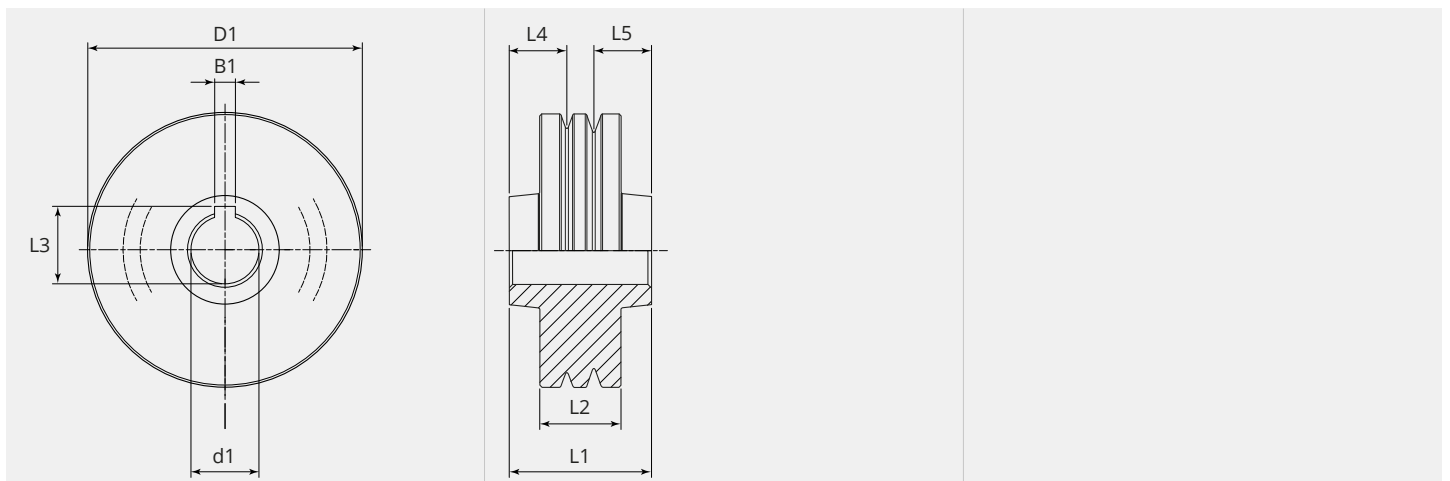

**DIMENSIONAL DRAWING**

<b>L1 (mm):</b>	21.00
<b>L2 (mm):</b>	12.00
<b>L3 (mm):</b>	11.40
<b>L4 (mm):</b>	8.50
<b>L5 (mm):</b>	8.50
<b>B1 (mm):</b>	3.05
<b>D1 (Ø):</b>	40
<b>d1 (Ø):</b>	10.00

From 300 pieces we produce your personal feed roll with logo. On request feed rolls are also available in stainless steel.