

Feed Roll with keyway 37mm 0.8+1.0 for aluminium wire

Suitable for series: ME2500-37, ME2600-37

Item number:	137005
Product weight (kg):	0.102 kg
Packing unit:	1



PRODUCT DESCRIPTION

Suitable for series: ME2500-37, ME2600-37

TECHNICAL CHARACTERISTICS

Wire (mm):	0.8 + 1.0
Welding wire:	Aluminium
Groove shape:	U
Characteristics of the groove:	flat
Type of setting:	Keyway
Material:	Hardened steel
Surface:	Black-finish
Arrangement Rolls:	Bottom

DIMENSIONAL DRAWING

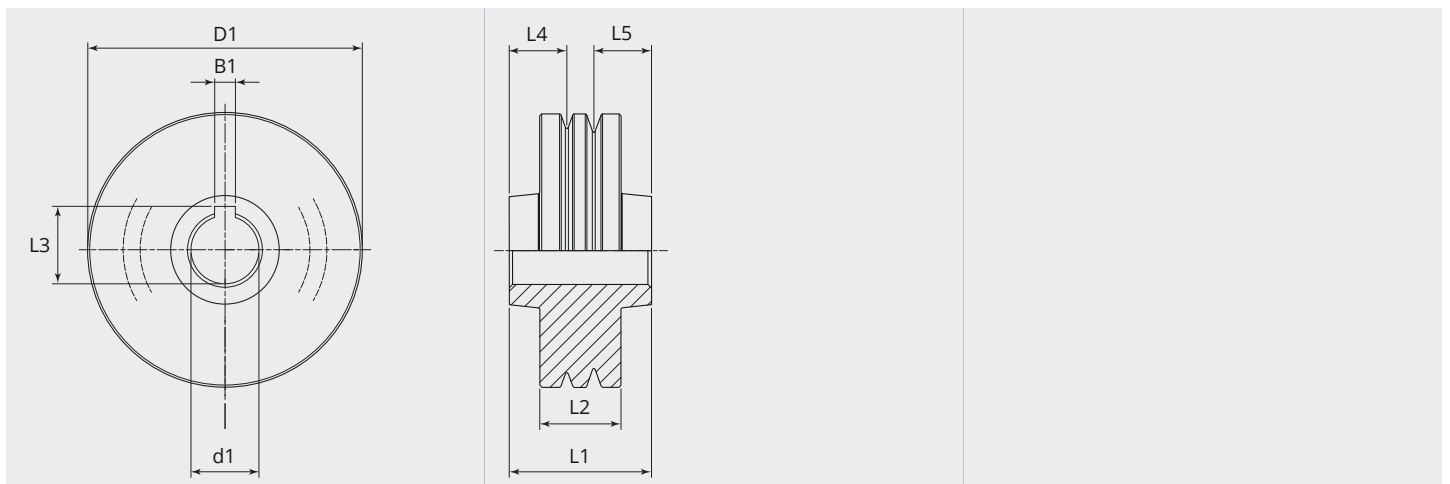

DIMENSIONAL DRAWING

L1 (mm):	21.00
L2 (mm):	12.00
L3 (mm):	11.40
L4 (mm):	8.50
L5 (mm):	8.50
B1 (mm):	3.05
D1 (Ø):	37
d1 (Ø):	10.00

From 300 pieces we produce your personal feed roll with logo. On request feed rolls are also available in stainless steel.