

Connection Tube with locknut and clamp ring L=91.5mm M12x1.5

Applies for central adaptor machine side

Item number:	119295
Packing unit:	1



PRODUCT DESCRIPTION

Applies for central adaptor machine side

TECHNICAL CHARACTERISTICS

Version:	Round
Terminal side:	Machine
Material:	Brass

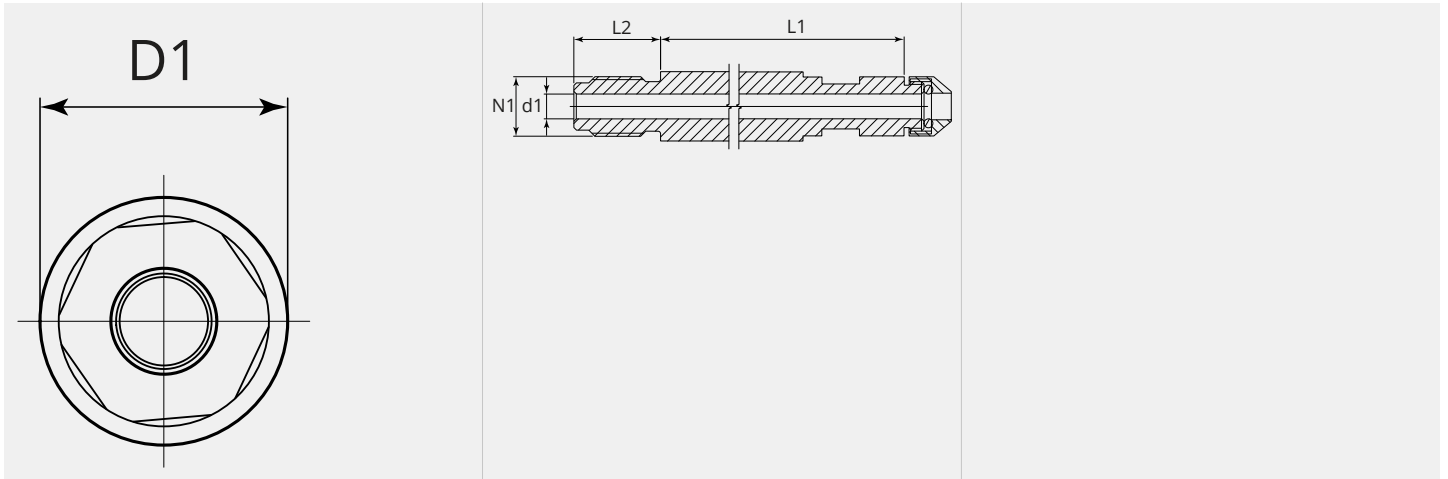
DIMENSIONAL DRAWING

DIMENSIONAL DRAWING

L1 (mm):	91.5
L2 (mm):	17.5
D1 (Ø):	14
d1 (Ø):	5.0
N1:	M12x1.5