

Feed Roll 30mm 1.4+1.6 for steel wire

Suitable for series: ME8900, ME9900-4R in conjunction with a suitable ball bearing and gear ring

Item number:	117932
Product weight (kg):	0.042 kg
Packing unit:	1



PRODUCT DESCRIPTION

Suitable for series: ME8900, ME9900-4R in conjunction with a suitable ball bearing and gear ring

TECHNICAL CHARACTERISTICS

Wire (mm):	1.4 + 1.6
Welding wire:	Steel
Groove shape:	V
Characteristics of the groove:	flatt
Type of setting:	Ball bearing
Material:	Hardened steel
Surface:	Black-finish
Arrangement Rolls:	Bottom

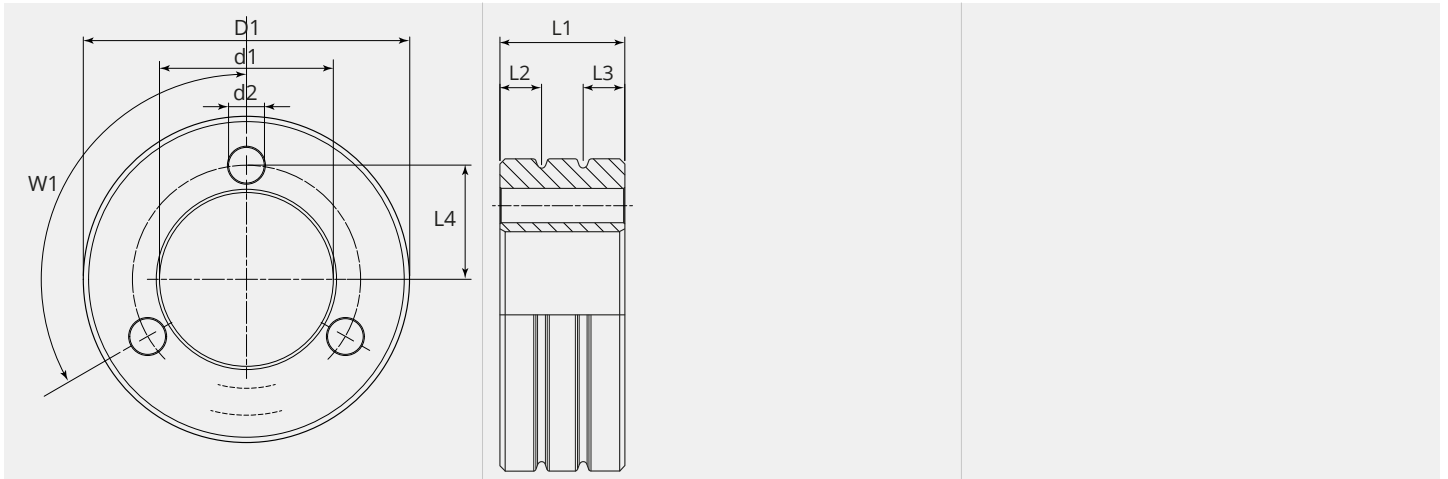
DIMENSIONAL DRAWING

DIMENSIONAL DRAWING

L1 (mm):	12.00
L2 (mm):	4.00
L3 (mm):	4.00
L4 (mm):	10.50
D1 (Ø):	30
d1 (Ø):	16.00
d2 (Ø):	3.30
W1 (°):	3 x 120

From 300 pieces we produce your personal feed roll with logo. On request feed rolls are also available in stainless steel.