

Feed Roll D22mm 1.6 for cored wire

In conjunction with our Push-Pull system.

Item number:	117498
Product weight (kg):	0.009 kg
Packing unit:	1



PRODUCT DESCRIPTION

In conjunction with our Push-Pull system.

TECHNICAL CHARACTERISTICS

Wire (mm):	1.6
Groove shape:	V
Characteristics of the groove:	knurled
Welding wire:	Cored wire
Type of setting:	Push-Pull / MEXDRIVE
Setting:	gear adaptor
Arrangement Rolls:	Top and bottom
Material:	Hardened steel
Surface:	Black-finish
Suitable:	Push-Pull / MEXDRIVE

DIMENSIONAL DRAWING

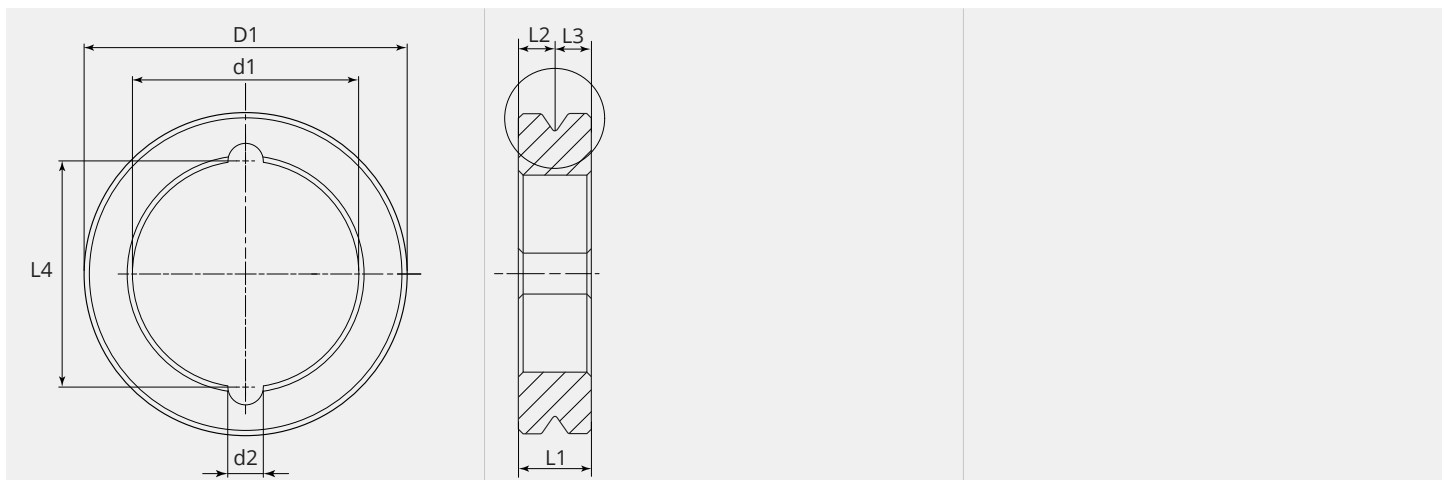

DIMENSIONAL DRAWING

L1 (mm):	5.00
L2 (mm):	2.50
L3 (mm):	2.50
L4 (mm):	13.50
D1 (Ø):	22
d1 (Ø):	13.56
d2 (Ø):	2.80

From 300 pieces we produce your personal feed roll with logo. On request feed rolls are also available in stainless steel.