

Motor 24VDC, 155rpm, 91.2watt

Left side

Item number:	117200
Product weight (kg):	1.6 kg
Packing unit:	1

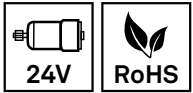

PRODUCT DESCRIPTION

Left side

TECHNICAL CHARACTERISTICS

Speed (rpm):	155
Operating voltage DC (V):	24
Current (A):	3.8
Power (W):	91.2
Additional:	-
Version:	Left
Wire speed 30mm feedroll (m/min.):	14.61
Wire speed 37mm feedroll (m/min.):	18.02
Wire speed 40mm feedroll (m/min.):	19.48
Active cooling:	no
Suitable:	ME8900, ME9300, ME9500, ME9800, ME9900-4R, ME2000

DIMENSIONAL DRAWING

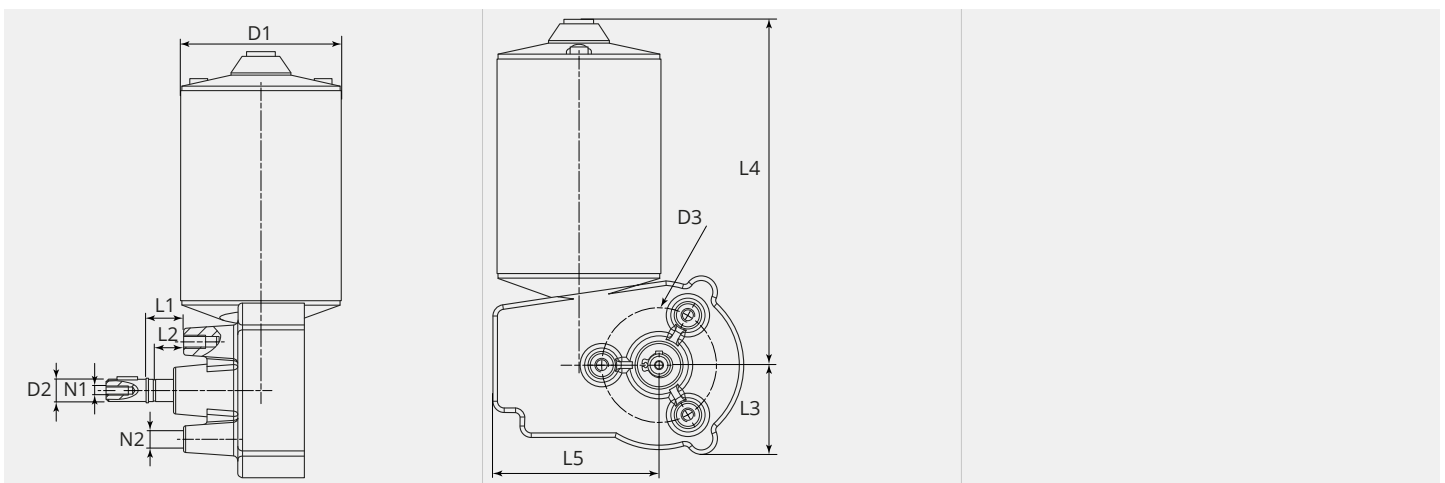

DIMENSIONAL DRAWING

L1 (mm):	17.0
L2 (mm):	13.7
L3 (mm):	39.5
L4 (mm):	153.0
L5 (mm):	73.5
D1 (Ø):	72.5
D2 (Ø):	10-h6
D3 (Ø):	50.8
N1:	M4
N2:	M6