

2R-Vorschubeinheit, rechts MEFR2521-40

Artikelnummer: 102150

VPE: 1



TECHNISCHE EIGENSCHAFTEN

Vorschubrolle:	40
Anzahl Rollen:	2
Angetriebene Rollen:	1
Anordnung Rollen:	Unten
Rahmenmaterial:	Aluminium
Druckarm:	Aluminium
Motorpositionen:	9

MASSBILD

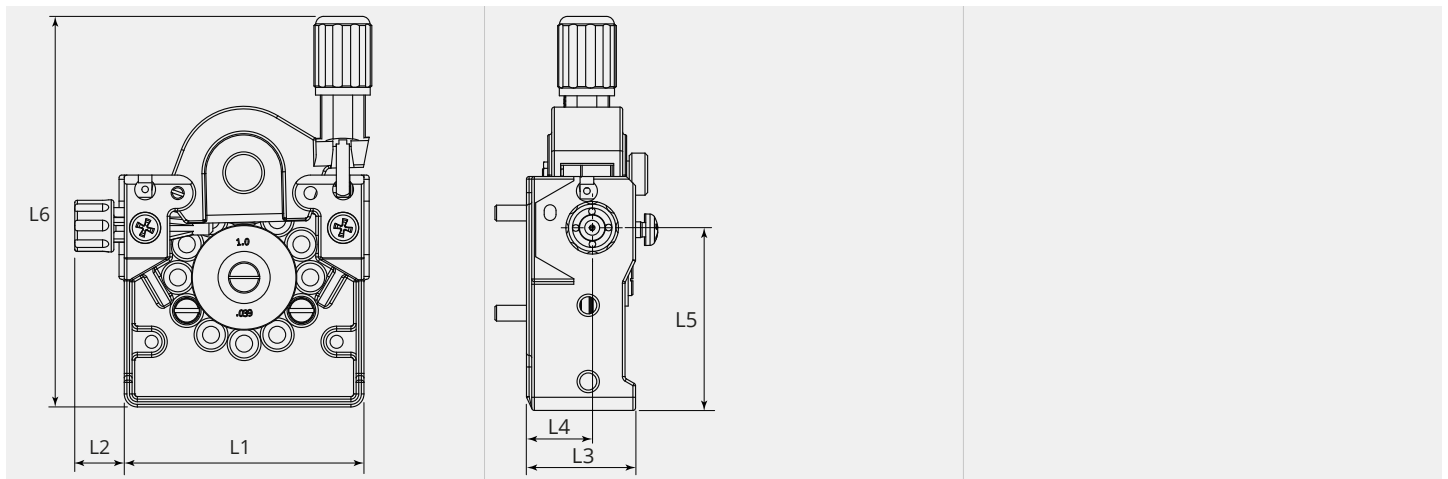



MASSBILD

L1 (mm):	92.0
L2 (mm):	19.0
L3 (mm):	41.5
L4 (mm):	25.0
L5 (mm):	69.5
L6 (mm):	149.9