

2R-Wire Drive System, right MEFR2522-37

Item number: 101802

Packing unit: 1



TECHNICAL CHARACTERISTICS

Wire feedroll:	37
Quantity rolls:	2
Driven rolls:	2
Arrangement Rolls:	Bottom
Frame Material:	Aluminium
Pressurearm:	Aluminium
Motor positions:	9

DIMENSIONAL DRAWING

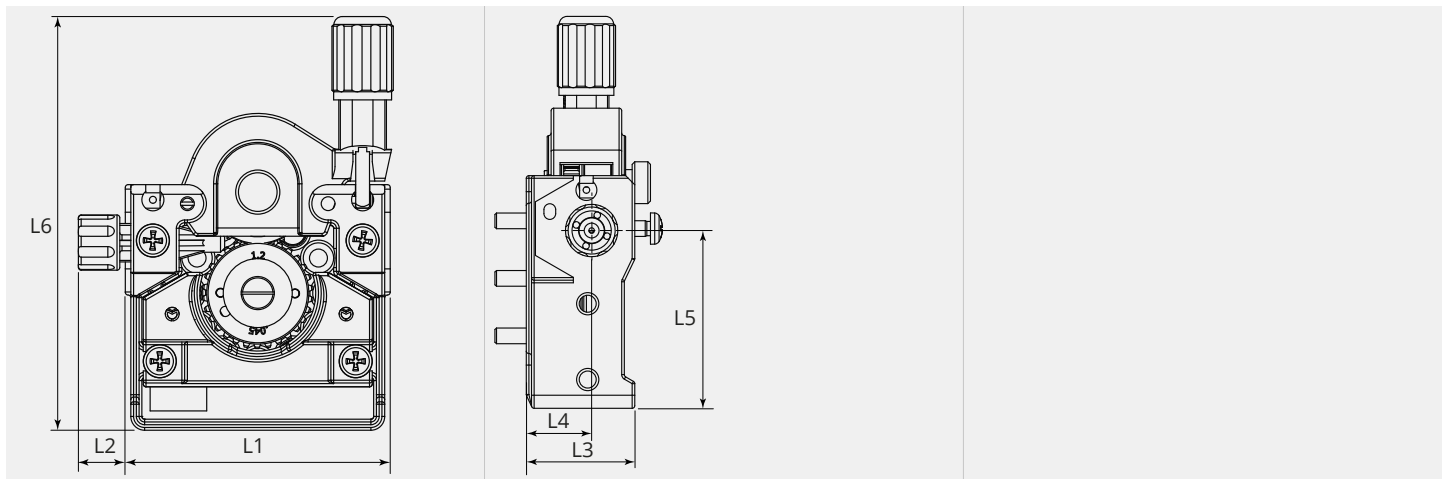



DIMENSIONAL DRAWING

L1 (mm):	96.0
L2 (mm):	17.0
L3 (mm):	41.5
L4 (mm):	25.0
L5 (mm):	68.0
L6 (mm):	149.9