

## 2R-Wire Drive System, right MEFR2521-37

Item number: 101750

Packing unit: 1



## TECHNICAL CHARACTERISTICS

Wire feedroll:	37
Quantity rolls:	2
Driven rolls:	1
Arrangement Rolls:	Bottom
Frame Material:	Aluminium
Pressurearm:	Aluminium
Motor positions:	9

## DIMENSIONAL DRAWING

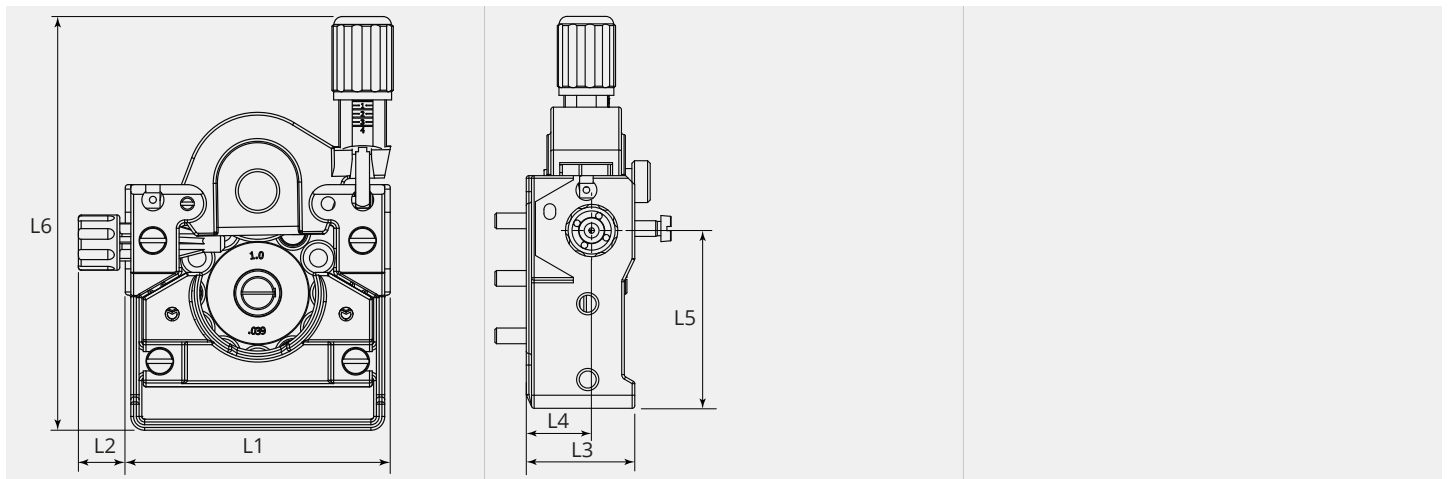



**DIMENSIONAL DRAWING**

<b>L1 (mm):</b>	92.0
<b>L2 (mm):</b>	19.0
<b>L3 (mm):</b>	41.5
<b>L4 (mm):</b>	25.0
<b>L5 (mm):</b>	68.0
<b>L6 (mm):</b>	149.9