

# 4R-Wire Drive System compl. MEFRC2042-40

Item number: 100076  
Product weight (kg): 1.387 kg  
Packing unit: 1



## TECHNICAL CHARACTERISTICS

Wire feedroll:	40
Quantity rolls:	4
Driven rolls:	2
Arrangement Rolls:	Bottom
Frame Material:	Aluminium
Pressurearm:	Aluminium
Motor positions:	12

## DIMENSIONAL DRAWING

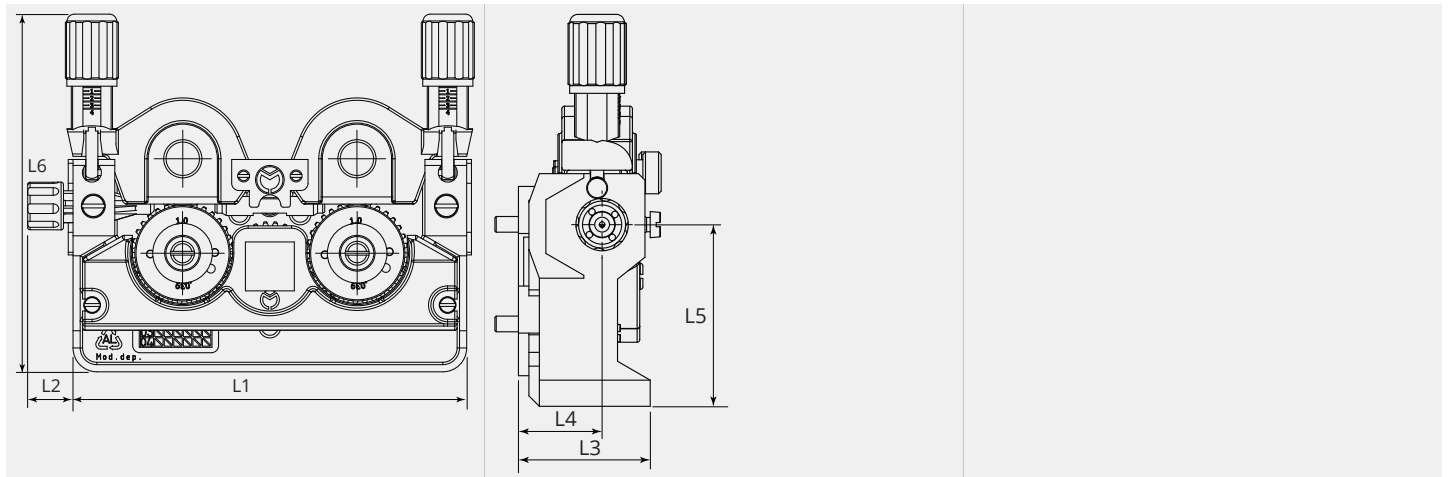



**DIMENSIONAL DRAWING**

<b>L1 (mm):</b>	165.0
<b>L2 (mm):</b>	19.0
<b>L3 (mm):</b>	50.4
<b>L4 (mm):</b>	32.0
<b>L5 (mm):</b>	69.5
<b>L6 (mm):</b>	150.0