

Inlet Guide brass for 0.5 - 1.6mm Wire

Applies for series: ME9800

Item number:	100001
Product weight (kg):	0.02 kg
Packing unit:	1



PRODUCT DESCRIPTION

Applies for series: ME9800

TECHNICAL CHARACTERISTICS

Wire (mm):	0.5 - 1.6
Welding wire:	Steel / aluminium / cored wire
Material:	Brass
Suitable:	ME9800

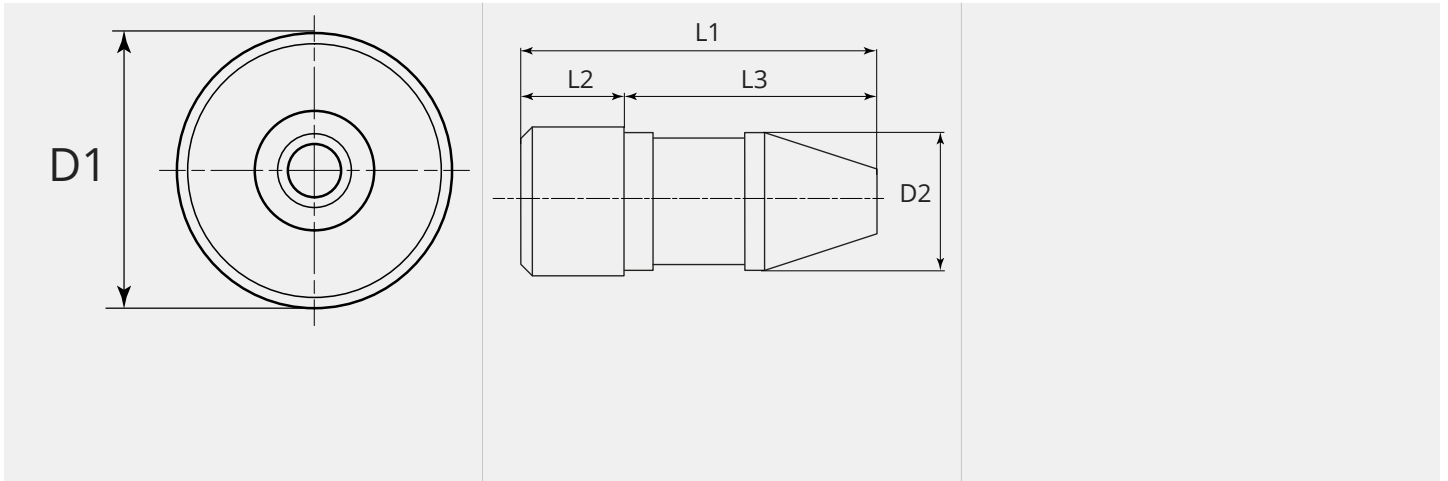
DIMENSIONAL DRAWING

DIMENSIONAL DRAWING

L1 (mm):	31.0
L2 (mm):	9.0
L3 (mm):	22.0
D1 (Ø):	13
D2 (Ø):	12.0